

NR・NRE SERIES

NR・NREシリーズは、当社独自の設計によるセミシリンダー(外径280mm)、超高速・高性能両面飾り偏平縫いミシンです。

1本針(ジーンズ裾三ツ巻き用)から4本針(NR9804GD)まで、平縫い、かぶせ縫い、裾引き、ゴム付け、天ゴム付けなど、応用範囲の広いモデルです。また、用途によりプラー、右メス、左メスを装備したモデルもあります。(また、新モデルのNREは、下糸捌き機構をマシン外部に設置することにより、扱いやすさをさらに増しています。さらに5種類のゲージパーツを同梱した“MG”は、あらゆる用途に対応します。)

NR・NRE series is a high speed and high performance with top and bottom cover stitch machine of cylinder bed (circumference 280mm), which is uniquely designed by us. This series has wide range of models from 1 needle (for hemming of jeans) to 4 needle (NR9804GD), and for various kinds of operations like plain stitching, covering, hemming, attaching elastic, attaching pre-closed elastic to men's briefs, and so on. Also, available for models equipped with puller, right knife, left knife, and so on. Stitch length can be adjusted by a push button easily (max. 4mm, 6 stitches/inch). A maximum sewing speed is 6000rpm, so the productivity will be upgraded. The latest line of NRE that has just been introduced has the looper thread take-up cam outside of the machine for easier handling. The new subclass MG includes 5 different gauges in 1 machine for various purposes

NR・NRE series alta velocidad, con recubridor superior y inferior, cama cilíndrica circunferencia (280mm) diseñada por nosotros. Esta serie tiene varios modelos; de una aguja para ribete jeans y de 4 agujas (NR9804GD). Se puede aplicar en varios como puntada regular—para cubrir ribete, pegar elastico, adaptar elastico en prendas pre-cerradas, y otras funciones. Tambien modelos con puler y cuchillos de izquierda y derecha, longitud de puntada facilmente se ajusta por medio del boton (max. 4mm, 6 puntadas/pulgada). Velocidade maxima de coser 6000rpm. Y, nuevo modelo “NRE” realiza facil mantenimiento por “Mecanismo de levanta-hilo de garfio equipado fuera de maquina”. Y tambien, la subclase “MG” viene con 5 tipos de aplicaciones para multi-operacion.

NR・NRE 系列是我公司独特设计的半筒式<外周 280mm>超高速,高性能两面绷缝的缝纫机。1针<牛仔裤卷边缝>4针细缝,盖缝,卷边,松紧带缝等广范围的系列缝纫机。

另外,新款的NRE系列是根据打线器设定在外边,在它的附近发生的问题可容易解决。而且,装有5种的针位的MG系列可对应各种的用途

NR・NRE・RX/UFシリーズ 表示方法

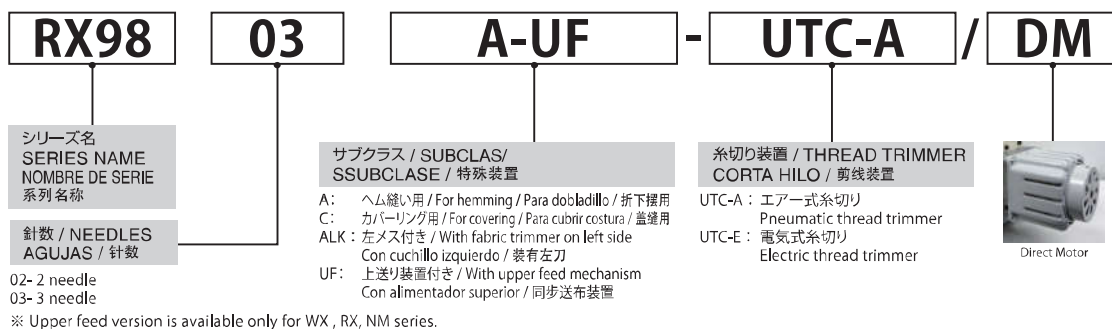
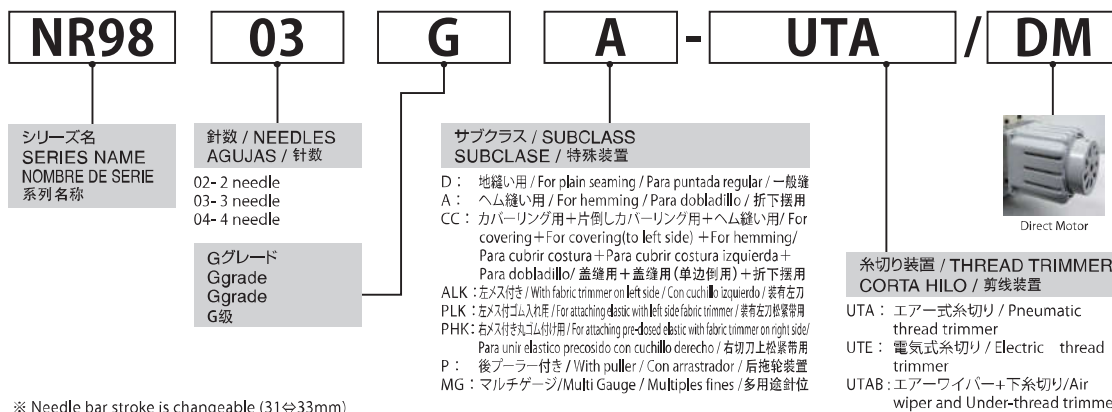

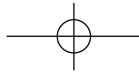

INDUSTRIAL SEWING MACHINES PRODUCTS GUIDE

TOP & BOTTOM

NW・WX・NL SERIES

KC SERIES

NR・NR・RX・UF SERIES

NC・NM・UF SERIES

NFS SERIES

NR9803GA

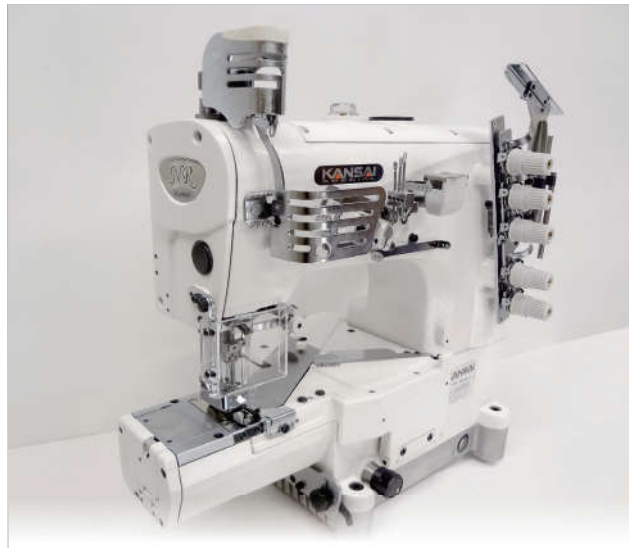
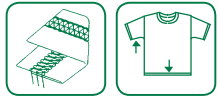

3本針両面飾りセミシリンダー型裾引き用マシン

3 needle, cylinder bed, top and bottom cover stitch machine for hemming

3 agujas, cama cilíndrica, recubridor superior e inferior para dobladillos

3 针两面装饰，筒式绷缝机



MODEL	No. of Needle	No. of Thread	Needle Type		Gauge (Inch)	No. of Stitch (Stitch/Inch)	Diff. Feed Ratio	Presser Foot Lift (mm)	Needle Bar Stroke (mm)	Max. Speed (rpm)
			Organ (#)	Schmetz (Nm)						
NR9803GA	3	5	UYX128GAS 9~14	UYX128GAS 60~90	7/32, 1/4	6~16 (1.6~4.2mm)	0.3~2.9	6	31 (31⇄33)	6000
NR9803GA-UTA										
NR9803GA-UTE										

NR9803GP



P - Gear puller
PE - Smooth puller



3本針両面飾りセミシリンダー、プーラー、ゴム入れ用マシン

3 needle, cylinder bed, top and bottom cover stitch machine with rear puller for attaching elastic

Cama cilíndrica 3 agujas recubridor superior e inferior. Para pegar elastico, con arrastrador

3 针两面装饰迹绷缝机带后拖轮，可上松紧带

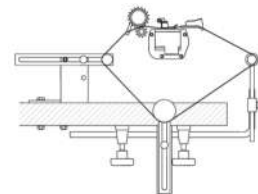

同梱品 / IN ACCESSORY BOX

MODEL	No. of Needle	No. of Thread	Needle Type		Gauge (Inch)	No. of Stitch (Stitch/Inch)	Diff. Feed Ratio	Presser Foot Lift (mm)	Needle Bar Stroke (mm)	Max. Speed (rpm)
			Organ (#)	Schmetz (Nm)						
NR9803GP	3	5	UYX128GAS 9~14	UYX128GAS 60~90	7/32, 1/4	6~16 (1.6~4.2mm)	0.3~2.9	6	33 (31⇄33)	4800
NR9803GP-UTA										
NR9803GP-UTE										

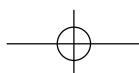

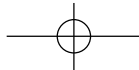

NR9803GCC



3本針両面飾りセミシリンダー型カバーリング用マシン

3 needle, cylinder bed, top and bottom cover stitch machine for left fold covering

Cama cilíndrica 3 agujas recubridor superior e inferior

3 针两面装饰线迹包边缝绉缝机





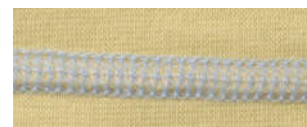



FRONT

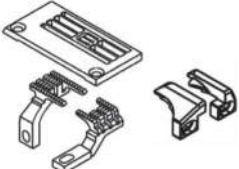

BACK

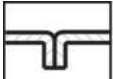
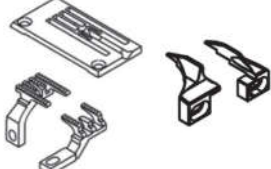
MODEL	No. of Needle	No. of Thread	Needle Type		Gauge (Inch)	No. of Stitch (Stitch/Inch)	Diff. Feed Ratio	Presser Foot Lift (mm)	Needle Bar Stroke (mm)	Max. Speed (rpm)
			Organ (#)	Schmetz (Nm)						
NR9803GCC	3	5	UYX128GAS 9~14	UYX128GAS 60~90	7/32, 1/4	6~16 (1.6~4.2mm)	0.3~2.9	6	31 (31↔33)	6000
NR9803GCC-UTA NR9803GCC-UTE										

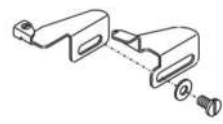
ゲージ比較 / GAUGE COMPARISON / comparación de las máquinas que cubre / 盖缝机的相比

 CL TYPE	 STANDARD	
 C TYPE	 IN ACCESSORY BOX	
 A TYPE	 IN ACCESSORY BOX	



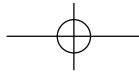

INDUSTRIAL SEWING MACHINES
PRODUCTS GUIDE

TOP & BOTTOM

NW・WX・NL SERIES

KC SERIES

NR・NR-E・RX-UF SERIES

NC・NM-UF SERIES

NFS SERIES

NR9803GPEHK-UTA



3本針下面飾りセミシリンダー
天ゴム付け用マシン

3 needle, cylinder bed machine
with fabric trimmer and smooth
puller for attaching pre-closed
elastic to men's underwears

3 agujas, máquina de cama de
cilindro con la recortadora de
tejido y el puller liso por atar el
preclosed elástico a las ropas
interior de hombres

3 针圆筒上松紧带缝纫机



・PEHK : Smooth Puller
・PGHK : Gear puller

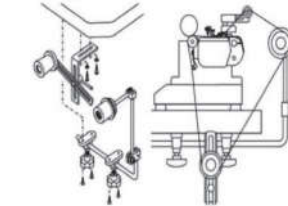

同梱品 / IN ACCESSORY BOX

■ NR-PHKのメスドロップ機構 / Drop knife system El sistema de caída de cuchillo / NR-PHK的刀组雨量装置

矢印のボタンとレバーにより、針板下面
で上メスの駆動を止めることができます。
メスを必要としない縫製の場合に、御使
用ください。

By pushing Button A & Lever B,
the height of the knife can be set
up under the surface of the needle
plate.

It is useful for the sewing operation
without fabric trimmer.

Empujando Botón UN & Palanca
B, la altura del cuchillo puede
prepararse bajo la superficie del
plato de la aguja.

Es útil para el funcionamiento de la
costura sin la recortadora de tejido.

使用箭头所指的按钮和连杆可以控制针板下面刀组的运动。
在缝制操作上不需要用刀片的时候，可以采用这项功能。

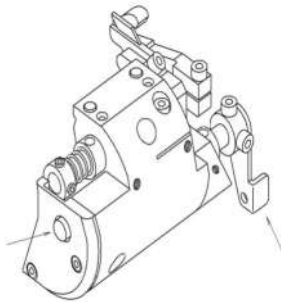

■ プーラーは仕様によりギヤーまたはゴムプーラーがお選びいただけます。 Please choose either "Gear puller (PG-HK)" or "Smooth puller (PE-HK) depending on your specification Se puede elegir "Puller de diente (PG-HK)" o "Puller de goma (PE-HK) dependiendo de su especificación

根据缝制的要求可选择使用齿轮拖轮和橡胶平拖轮。

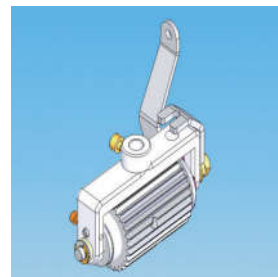

PGHK
(Gear puller)

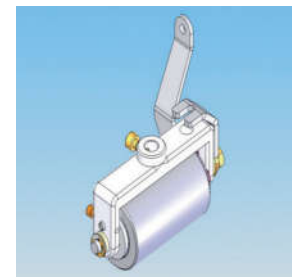

PEHK
(Smooth puller)

MODEL	No. of Needle	No. of Thread	Needle Type		Gauge (Inch)	No. of Stitch (Stitch/Inch)	Diff. Feed Ratio	Presser Foot Lift (mm)	Needle Bar Stroke (mm)	Max. Speed (rpm)
			Organ (#)	Schmetz (Nm)						
NR9803GPEHK	3	5	UYX128GAS 9~14	UYX128GAS 60~90	7/32, 1/4	6~16 (1.6~4.2mm)	0.3~2.9	5	33 (31↔33)	4800
NR9803GPGHK										
NR9803GPEHK-UTA										
NR9803GPGHK-UTA										

NR9803GALK-UTA

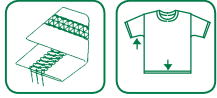

3本針両面飾りセミシリンダー
裾引き用左メス付きミシン

3 needle, cylinder bed, top and bottom cover stitch machine with a fabric trimmer built in to the left of the needles for hemming

3 agujas, cama cilíndrica, recubridor superior e inferior con cuchillo izquierdo para dobladillo

3 针两面装饰缝线机带左切布刀

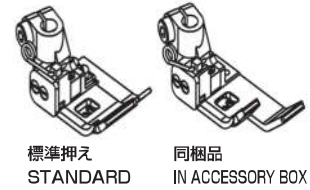

標準押え
STANDARD

同梱品
IN ACCESSORY BOX

MODEL	No. of Needle	No. of Thread	Needle Type		Gauge (Inch)	No. of Stitch (Stitch/Inch)	Diff. Feed Ratio	Presser Foot Lift (mm)	Needle Bar Stroke (mm)	Max. Speed (rpm)
			Organ (#)	Schmetz (Nm)						
NR9803GALK	3	5	UYX128GAS 9~14	UYX128GAS 60~90	7/32, 1/4	6~16 (1.6~4.2mm)	0.3~2.9	5500	33 (31↔33)	5500
NR9803GALK-UTA										

NR OTHER MODELS TECHNICAL DATA 仕様明細

MODEL	No. of Needle	No. of Thread	Needle Type		Gauge (Inch)	No. of Stitch (Stitch/Inch)	Diff. Feed Ratio	Upper Feed Amount (mm)		Presser Foot Lift (mm)	Needle Bar Stroke (mm)	Max. Speed (rpm)
			Organ (#)	Schmetz (Nm)				↔	↑↓			
NR9804GD	4	6	SM1014H #10S	SM1014H #70	6mm, 6.4mm	6~16 (1.6~4.2mm)	0.3~2.9	↔	↑↓	6	31	4000
NR9804GD-UTA												
NR9803GPLK	3	5	UYX128GAS 9~14	UYX128GAS 60~90	7/32, 1/4	6~16 (1.6~4.2mm)	0.3~2.9	↔	↑↓	6	33 (31↔33)	4800
NR9803GPLK-UTA NR9803GPLK-UTE												

RX-UF MODELS TECHNICAL DATA 仕様明細

RX9802A-UF	2	4	UYX128GAS 9~14	UYX128GAS 60~90	3/16	6~16 (1.6~4.2mm)	0.3~2.9	1~7	3.5~6	6	33	5500
RX9803A-UF	3	5			7/32, 1/4							
RX9802A-UF/UTC-A/E RX9802A-UF/UTC-AW/EW	2	4			3/16							
RX9803A-UF/UTC-A/E RX9803A-UF/UTC-AW/EW	3	5			7/32, 1/4							

※ Upper feed machines are only available for RX series

INDUSTRIAL SEWING MACHINES
PRODUCTS GUIDE

TOP & BOTTOM

NW・WX・NL SERIES

KC SERIES

NR・NRE・RX・UF SERIES

NC・NM・UF SERIES

NFS SERIES

NRE9803GCC



3本針両面飾り縫いセミシリンダー外部
ハマグリ機構マシン
マルチゲージ(A,D,C,CL)

3 needle, cylinder bed, top and
bottom cover stitch machine with
exterior looper thread takeup cam
(4 type gauge set included)

3 agujas, cama del cilindro, cima
y máquina de puntada de tapa de
fondo con looper exterior enhebran
la toma a la leva (4 juegos de
medida de tipo incluyeron)

小方头 3 针 5 线绷缝机, 打线拖轮外置式
多用途针位 (下摆, 基本缝, 立骨, 倒骨)

MODEL	No. of Needle	No. of Thread	Needle Type		Gauge (Inch)	No. of Stitch (Stitch/Inch)	Diff. Feed Ratio	Presser Foot Lift (mm)	Needle Bar Stroke (mm)	Max. Speed (rpm)
			Organ (#)	Schmetz (Nm)						
NRE9803GCC	3	5	UYX128GAS	UYX128GAS	7/32, 1/4	6~16 (1.6~4.2mm)	0.3~2.9	6	31 (31↔33)	6000
NRE9803GCC-UTA			9~14	60~90						
NRE9803GCC-UTE										

NRE9803GP



P - Gear puller
PE - Smooth puller



3本針両面飾りセミシリンダー、外部
ハマグリ機構プーラー、ゴム入れ用ミシ
ン

3 needle, cylinder bed, top and
bottom cover stitch machine with
exterior looper thread takeup cam
with rear puller for attaching elastic

3 agujas, cama del cilindro, cima
y máquina de puntada de tapa de
fondo con looper exterior enhebran
la toma a la leva Para pegar
elastico, con arrastrador

小方头 3 针 5 线绷缝机, 打线拖轮外置式,
带后拖轮

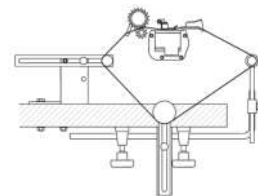

同梱品 / IN ACCESSORY BOX

MODEL	No. of Needle	No. of Thread	Needle Type		Gauge (Inch)	No. of Stitch (Stitch/Inch)	Diff. Feed Ratio	Presser Foot Lift (mm)	Needle Bar Stroke (mm)	Max. Speed (rpm)
			Organ (#)	Schmetz (Nm)						
NRE9803GP	3	5	UYX128GAS	UYX128GAS	7/32, 1/4	6~16 (1.6~4.2mm)	0.3~2.9	6	33 (31↔33)	4800
NRE9803GP-UTA			9~14	60~90						

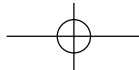

NRE9803GMG

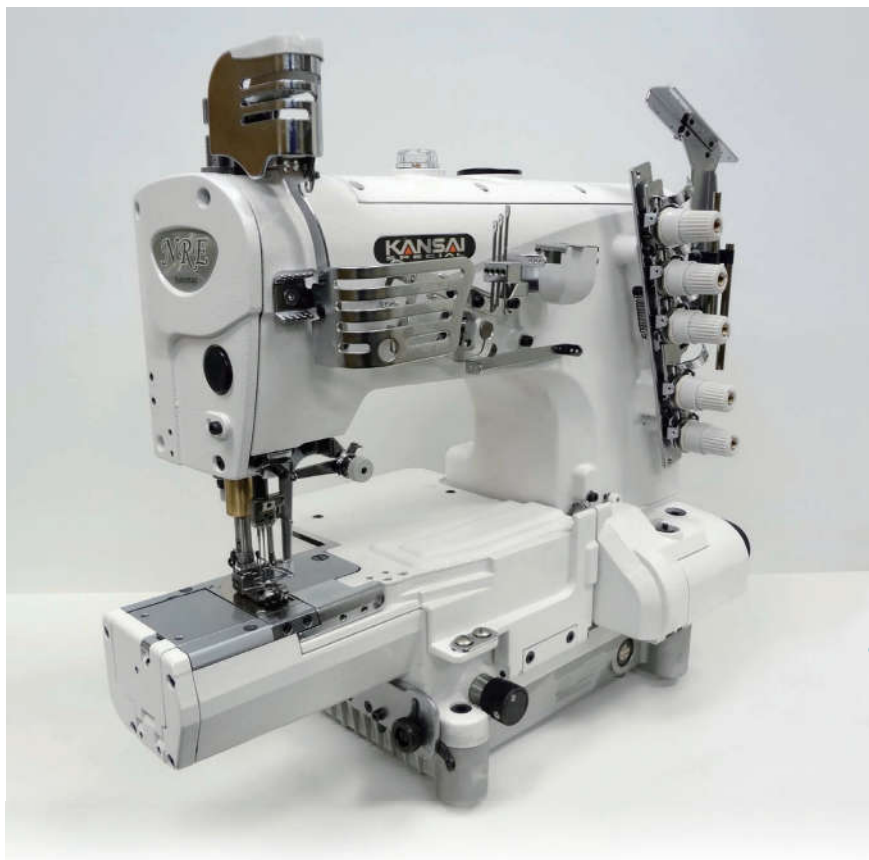

3本針両面飾り縫い外部ハグリ機構
マシン
マルチゲージ(A,D,C,CL,F)

3 needle, cylinder bed, top and
bottom cover stitch machine with
exterior looper thread takeup
cam(5 type gauge sets included)

3 agujas, cama del cilindro, cima
y máquina de puntada de tapa de
fondo con looper exterior enhebran
la toma a la leva (5 juegos de
medida de tipo incluyeron)

3 针两面缝装饰绷缝机 (筒式台, 打线器
设定在外边, 可以选各种针位)



Tape binding / Pegar cinta / 滚条

MODEL	No. of Needle	No. of Thread	Needle Type		Gauge (Inch)	Nc. of Stitch (Stitch/Inch)	Diff. Feed Ratio	Presser Foot Lift (mm)	Needle Bar Stroke (mm)	Max. Speed (rpm)
			Orgen (#)	Schmetz (Nm)						
NRE9803GMG	3	5	UYX128GAS	UYX128GAS	7/32, 1/4	6~16 (1.6~4.2mm)	0.3~2.9	6	31 (31↔33)	6000
NRE9803GMG-UTA NRE9803GMG-UTE			9~14	60~90						

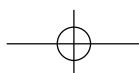

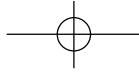

■ **D type Plain / Puntada regular / 辅助平台**
Plain

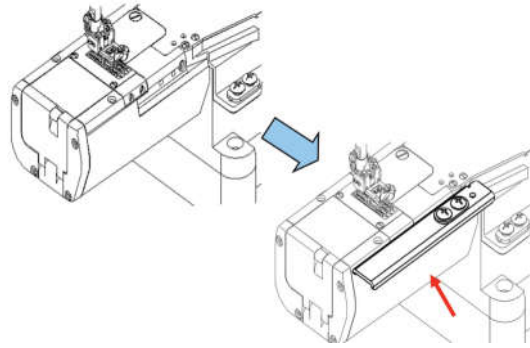

■ **C/GL type Covering / Cubrir costuras de overlock / 盖缝**
Plain to Covering

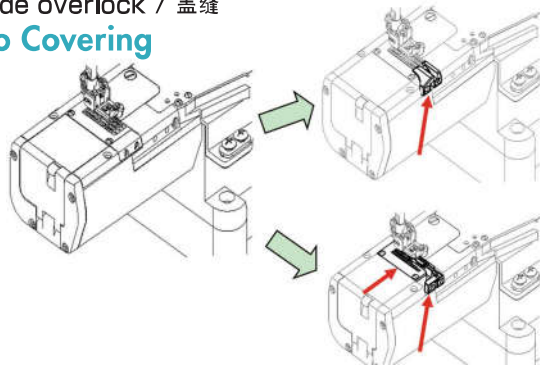

■ **F type Tape binding / Pegar cinta / 滚条**
Plain to Tape binding

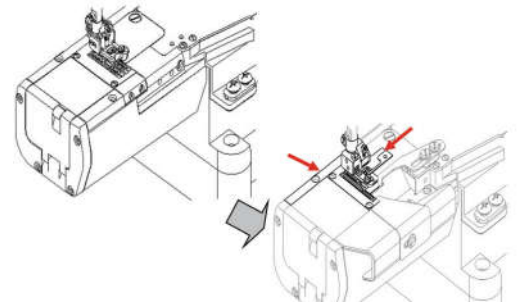

■ **A type Hemming / Doblado / 折下摆**
Plain to Hemming

