

Great Variety of model series are supported by
our productivity and quality.

**INDUSTRIAL SEWING MACHINES
PRODUCTS GUIDE**

KANSAI
SPECIAL

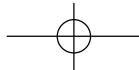

INDUSTRIAL SEWING MACHINES
PRODUCTS GUIDE



DOUBLE CHAIN

二重環縫いミシン

P.3 ~ P.14

DLR SERIES
DVK・B SERIES
NW2202 SERIES
SX SERIES
HDX SERIES

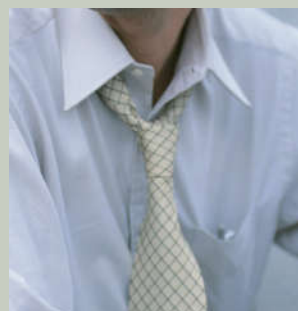

MULTI-NEEDLE

多本針二重環縫いミシン

P.15 ~ P.40

DFB SERIES
NB SERIES
FX SERIES
DX SERIES
FBX SERIES

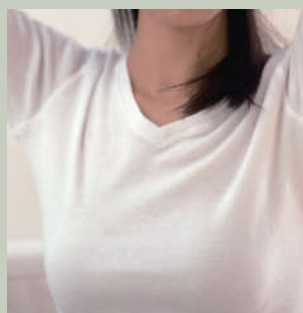

TOP & BOTTOM

偏平縫いミシン

P.41 ~ P.66

NW SERIES
WX SERIES
NL SERIES
KC SERIES
NR・NRE SERIES
NC SERIES
NFS SERIES



DECORATION

二重環縫い飾りミシン

P.67 ~ P.72

PX SERIES
MAC SERIES
MMX SERIES



OVER LOCK

オーバーロックミシン

P.73 ~ P.78

JJ SERIES



OPTIONAL DEVICES

オプションデバイス

P.79 ~ P.81

OPTIONAL DEVICES

 **MORIMOTO MFG. CO., LTD.**

CONTENTS

DOUBLE CHAIN			
DLR SERIES	3	FX4412P-UTC	32
DLR1503PTF	4	DX SERIES	34
DLR1508P	4	DX9900-4U	35
DLR1509P	4	DX9902-3U	35
DLR1508SPF	5	DX9904U	36
DLR1509SPF	5	FBX SERIES	37
DVK - B SERIES	7	FBX1104P	38
DVK1702PMD	8	FBX1106P	38
B2000C	8	FBX1102PA-1S	39
NW2202 SERIES	9	FBX1104PA-2WAC	39
NW2202GC	10	FBX1102PA-2WAC-LC (Lock stitch & Chain stitch)	40
NW2202GPC	10		
SX SERIES	11	TOP & BOTTOM	
SX6803PD	12	NW - WX - NL SERIES	41
SX6803PD-DP	12	NW8803GD	42
HDX SERIES	13	NW8803GF	42
HDX1101	14	NW8803GMG	43
HDX1102	14	NW8803GCL	44
		WX8803F-UF	44
		NW8803GD-WD	45
		WX8803EMK	45
		NW8842-1G	46
		WX8803-1S	46
		NW8804GD	47
		NL5802GLR	47
		NL5802GL	48
		NL5802GTMF	48
		NL5803GPXP	49
		KC SERIES	50
		KC2703/UTC-E	50
		NR - NRE SERIES	51
		NR9803GA	52
		NR9803GP	52
		NR9803GCC	53
		NR9803GPEHK-UTA	54
		NR9803GALK-UTA	55
		NRE9803GCC	56
		NRE9803GP	56
		NRE9803GMG	57
		NC SERIES	59
		NC1103GDA-UTE	60
		NC1103GCL-UTA	60
		NC1001SJ/NC1001J	61
		NFS SERIES	63
		NFS6604GS	64
		NFS6604GSL	64
		NFS6604GLM-DD	65
		NFS6604GMH-DD/CS-2	65
		NFS6604GMH-B-DD/CS-2	66
		DECORATION	
		PX - MAC SERIES	67
		PX302-4W	68
		PX301-2S	68
		PX302-5W	69
		MAC100	70
		MMX SERIES	71
		MMX3303F	72
		OVER LOCK	
		JJ SERIES	73
		JJ3014GH-01M	74
		JJ3014GH-40M	74
		JJ3014GE-01H	74
		JJ3116GS-01M	75
		JJ3116GH-01H	75
		JJ3004GS-20F	76
		JJ3143GH-90M	76
		JJ3116E-03XK	77
		UK2000GH-WG	77
		OPTIONAL DEVICES	
		OPTION	79
		"DOUBLE CHAIN" シリーズ用 オプション	79
		"Multi-needle" シリーズ用 オプション	79
		"TOP & BOTTOM" シリーズ用 オプション	80
		"Overlock" シリーズ用 オプション	81
		FX SERIES	29
FX4404P	30		
FX4404PMD	30		
FX4404PMD (with metering device)	30		
FX4406PL	31		
FX4404PSF	31		
FX4404P-UTC	32		
DFB SERIES	15		
DFB1404P	16		
DFB1404PMD	16		
DFB1404PMD (with metering device)	16		
DFB1404PSF	17		
DFB1412PL	17		
DFB1403PSM-H	18		
DFB1412PQ	19		
DFB1412PS	19		
DFB1412PS-ET	19		
DFB1412PSSM-ET	20		
DFB1412PTV	21		
NB SERIES	23		
NB1433PSSM-ET	24		
NB1433PSSM-ET-MD	24		
NB1033PSSM	25		
NB1433PQSM	26		



DLR SERIES

DLR シリーズは、フラットベッド多針(1~6本針)2重環縫いミシンです。

ルーパー横振り機構の採用により中厚から厚物の縫製に最適です。ジーンズのタコ巻き縫い、腰帯付け、ゴム付けと応用範囲の広いシリーズです。また独自に開発したプーラー機構により高速運転時に送りむらも解消、安定した美しい縫い方が可能になりました。

DLR series is a flatbed, multi-needle (1~6 needles), double chain stitch machine with horizontal looper movement mechanism. Applications: lap seaming, attaching waistbands and line tapes, and inserting elastic.

Major features of DLR series are wide range of applications on mid heavy and heavy weight fabrics and Kansai Special's unique rear puller mechanism.

These features enable DLR series to produce durable and uniform stitches on mid heavy and heavy weight fabrics.

Cama plana, multiagujas, doble cadeneta, movimiento del garfio horizontal, perfecto para materiales de mediano a extra pesados, aplicaciones sobre costura en jeans, pegar elastico, el puler tiene un mecanismo que alimenta uniformemente la tela para mejor puntada a alta velocidad.

DLR 系列是平台式多针(1~6) 双重环缝纫机, 弯针横向运动机构使它能从中厚到厚料使用, 牛仔的卷边缝, 上腰, 上松紧等广范围使用。独自开发的后拖轮能保证高速运转时送布均衡, 线迹美观。

DLRシリーズ モデル表示方法

DLR	15	08	P
シリーズ名 SERIES NAME NOMBRE DE SERIE 系列名称	針数 NEEDLES AGUJAS 针数	サブクラス&オプション SUBCLASS & OPTION SUBCLASE Y OPCION 特殊装置和附属品	
	02:2本針 2 needle 2 agujas 2针	P: プーラー付 With rear puller Con arrastrador 后拖轮装置	PR: 左右二段式プーラー付(腰帯用カーブ縫ミシン) With independent lower puller (for curved waistbanding) Con arrastrador inferior independiente 装有左右分段式下拖轮 (上腰转弯缝)
	03:3本針 3 needle 3 agujas 3针	L: ライン付け For attaching line tape Para pegar cinta 滾条装置	PTF: プーラー+トラクターフット押え付(タコ巻縫いミシン) With rear puller & Tractor presser foot Con arrastrador y tractor-pie 后拖轮加特殊压脚 (埋夹缝纫机)
	04:4本針 4 needle 4 agujas 4针	PHD: プーラー付厚物用 With rear puller, For heavy duty fabric Con arrastrador, para material pesado 厚布料用后拖轮	V: プーラー無し Without puller Sin arrastrador 没有后拖轮
	08:4本針 4 needle 4 agujas 4针	PMD: プーラー+MD-1付(ゴム送り装置) With rear puller & MD-1 (metering device) Con arrastrador y docificador 后拖轮加前松紧带装置	SPF: 上下角度調整式プーラー付(腰帯用カーブ縫ミシン) With angle adjustable rear puller (for curved waistbanding) Con arratrador superior e inferior del mecanismo del angulo regulable 装有上下调试式后拖轮 (上腰转弯缝)
	09:6本針 6 needle 6 agujas 6针		

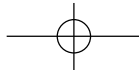

INDUSTRIAL SEWING MACHINES PRODUCTS GUIDE

DOUBLE CHAIN

DLR SERIES

DVK SERIES

NW2202 SERIES

SX SERIES

HDX SERIES

DLR1503PTF



3本針二重環縫いタコ巻縫い用ミシン

3 needle, flatbed, double chain stitch machine for lap seaming.

3 agujas para coser regazo.

3 针双重环缝包边缝纫机

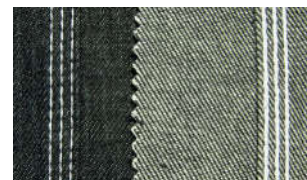

DLR1508P DLR1509P



4~6本針二重環縫い腰帯付け用
プラー付ミシン

4~6 needle, flatbed, double chain
stitch machine with puller for
waistbanding.

4~6 agujas (cinturera) con
arrastrador.

<DLR1508P>

4 针牛仔上腰缝纫机

<DLR1509P>

6 针自由针位牛仔上腰缝纫机



DLR-1508P



DLR-1509P

MODEL	No. of Needle	No. of Thread	Needle Type		Gauge (Inch)	No. of Stitch (Stitch/Inch)	Diff. Feed Ratio	Presser Foot Lift (mm)	Needle Bar Stroke (mm)	Max. Speed (rpm)
			Organ (#)	Schmetz (Nm)						
DLR1503PTF	3	6	TV×5 21	TV×5 130	1/4, 9/32	7~16	10	34	4500	
DLR1508P	4	8	TV×5 21	TV×5 130	1/4-3/4-1/4, 1/4-1-1/4, 3/16-1-3/16	7~16	10	34	4500	
DLR1509P	4(6)	8(12)	TV×5 21	TV×5 130	1/8-1/8-1-1/8-1/8	7~16	10	34	4500	

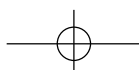

DLR1508SPF
(PAT・P)

DLR1509SPF

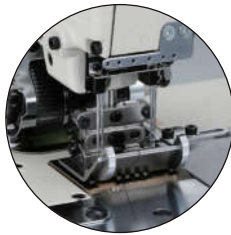

DLR1509SPF

4～6本針二重環縫い腰帯付け用(カーブ縫い)上下角度調整式プーラー付ミシン

4~6 needle, flatbed, double chain stitch machine with upper and independent lower pullers equipped with angle-adjustable mechanism, double feed dog system for curved waistbanding.

4~6 agujas para coser curvas con mecanismo del arrastrador superior e inferior ajustable.

4～6針双重環上腰用(转弯縫)装有上下可调试后拖轮缝纫机



SPFの仕様について

(WHAT'S ABOUT SPF ? / Sobre especificacion de SPF(Que es SPF?) / 对于SPF的用法(什么是SPF))

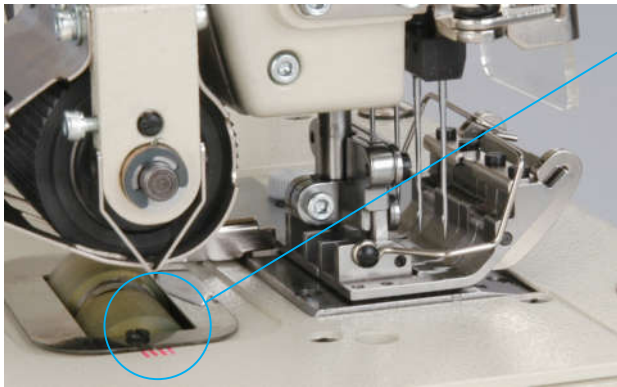

■ プーラー角度調節機構(后拖轮角度可调节)
Adjustable Puller angle system
El mecanismo del angulo del arrastrador regulable

カーブ縫いの角度によって、上下プーラーは回転し角度の調節が可能です。 Depending on angle of curved waistband, both upper and bottom pullers can be rotated, the indicator helps to change and fix angle of pullers.

Depende del angulo de la pretina curva, se puede hacer ajuste del angulo de arrastrador superior e inferior.

根据缝制的角度，可以调节上下拖轮的角度。

■ 2重送り歯仕様(装有双重送布牙)
Left and right-double feed dog system
El mecanismo del diente regulable

左右の送り歯の高さは、生地厚みやウエストノドのカーブ縫いの角度によってそれぞれを調節して頂く事が可能です。

Height of left and right feed dogs can be adjusted separately according to fabric weight and the angle of curved waistband. Dependiendo del grueso de material y el angulo de la pretina curva, separadamente se puede ajustar la altura de diente alimentador a la izquierda y la derecha.

根据左右送布牙的高度，布料的厚度，松紧带的转弯缝的角度可以做各种各样的调节来达到目的。

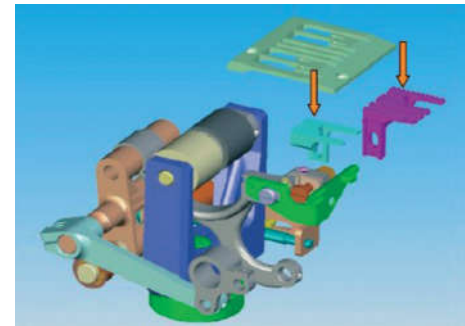

■ 1508と1509の比較(1508和1509的对比)
(Comparison between 1508P and 1509P)
(Omparacion entre 1580P y 1509P)

下図のように1509Pはゲージ交換も必要なく5種類のゲージサイズが利用できます。 As below drawing, 5 kinds of gauge sizes are available for 1509P without the conversion of gauge parts.

Como continuacion de dibujo, 5 tipos de calibres son disponibles para 1509P sin la conversion de calibre.

就像下图一样，1509P不需要更换针位就可以利用5种针位尺寸。

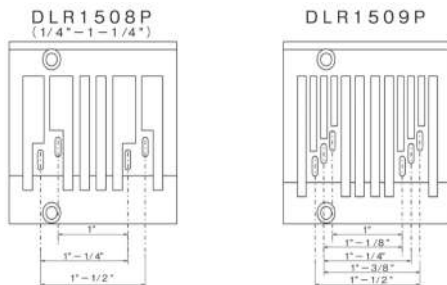

MODEL	No. of Needle	No. of Thread	Needle Type		Gauge (Inch)	No. of Stitch (Stitch/Inch)	Diff. Feed Ratio	Presser Foot Lift (mm)	Needle Bar Stroke (mm)	Max. Speed (rpm)
			Organ (#)	Schmetz (Nm)						
DLR1508SPF	4	8	TV×5 21	TV×5 130	1/4-1/4, 1/4-7/8-1/4	7~16		10	34	4500
DLR1509SPF	4(6)	8(12)	TV×5 21	TV×5 130	1/8-1/8-1/1/8-1/8	7~16		10	34	4500

OTHER TECHNICAL DATA 仕様明細

MODEL	No. of Needle	No. of Thread	Needle Type		Gauge(Inch)	No. of Stitch (Stitch/Inch)	Diff. Feed Ratio	Upper Feed Amount (mm)		Presser Foot Lift (mm)	Needle Bar Stroke (mm)	Max. Speed (rpm)
			Organ (#)	Schmetz (Nm)				↔	↑			
DLR1502P	2	4	UY×128GAS 14	UY×128GAS 90	3/16, 1/4, 5/16	7~16				8	27	4500
DLR1501PHD	1	2	TV×5 21	TV×5 130		7~14				10	34	4500
DLR1502PHD	2	4	TV×5 21	TV×5 130	1/4	7~14				10	34	4500
DLR1503PHD	3	6	TV×5 21	TV×5 130	1/4	7~14				10	34	4500
DLR1502PMD	2	4	UY×128GAS 11	UY×128GAS 75	3/16, 1/4, 5/16	8~16				8	27	4500
DLR1504P	4	8	UY×128GAS 14	UY×128GAS 90	1, 1-1/8	6~16				10	34	4500
DLR1504PMD	4	8	UY×128GAS 14	UY×128GAS 90	1, 1-1/8	6~16				10	34	4500
DLR1508PR	4	8	TV×5 21	TV×5 130	1/4-1-1/4, 3/16-1-3/16	7~16				10	34	4500
DLR1502V	2	4	UY×128GAS 14	UY×128GAS 90	3/16, 1/4, 5/16, 3/8, 1/2, 3/4	7~17				8	27	4500
DLR1503V	3	6	UY×128GAS 14	UY×128GAS 90	1/4	7~17				8	31	4500
DLR1502VHD	2	4	TV×5 21	TV×5 130	3/16, 1/4, 3/8	6~12				10	34	4500
DLR1503VHD	3	6	TV×5 21	TV×5 130	1/4	6~12				10	34	4500
DLR1503VTF	3	6	TV×5 21	TV×5 130	1/4	6~12				10	34	4500

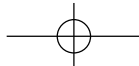

DVK・B SERIES

DVK・Bシリーズは、フラットベッド、1~2本針の二重環縫いミシンです。

ベルトループ縫いモデル(Bシリーズ)から、下着、水着のゴム付け(ゴム入れ)、極厚物のテント地、帆布、袋縫いまで幅広い製品に対応できるモデルです。

DVK・B series is a flatbed, 1-2 needle, double chain stitch and bottom cover stitch machine. Suitable for belt looping (B series), attaching and inserting elastic and sewing heavy fabrics. Major feature of DVK series is the wide range of applications for ultra heavy weight fabrics such as tent fabrics, sail fabrics and bag fabrics.

Cama plana de 1-2 agujas doble cadeneta un margen ancho para aplicaciones como unir elastico a ropa interior, vestidos de baño, tambien para telas pesadas carpas, y formacion de talegas, etc. Incluyendo maquina de pesadores(B series).

DVK系列是平台式1-2针双重环缝纫机。适合裤耳机型号<B系列>内衣, 游泳衣的上松紧, 超厚物帐篷, 帆布, 袋等各种产品使用。

DVK・Bシリーズ モデル表示方法

DVK

シリーズ名
SERIES NAME
NOMBRE DE SERIE
系列名称

17

02

針数
NEEDLES
AGUJAS
针数

02:2本針
2 needle
2 agujas
2针

P

プーラー / PULLER
ARRASTRADOR / 后拖轮

- B: ベルトループ用
For making belt loop
Para pasadores
裤环用
- P: プーラー付き
With puller
Con arrastrador
装有后拖轮
- PMD: プーラー+MD-1付(ゴム送り装置)
With rear puller & MD-1 (metering device)
Arrastrador & Docificador de elastico
后拖轮加前送松紧带装置
- MLH: ピンタック縫い
For making pintuck
Para puntada de pin-tuck
打褶缝

B

シリーズ名
SERIES NAME
NOMBRE DE SERIE
系列名称

2000

C

プーラー / PULLER
ARRASTRADOR / 后拖轮

- C: 前メス装置付 / With fabric trimmer
Con cuchillo frontal / 装有前切刀
- PC: 前メス装置付+プーラー / With fabric trimmer & Puller
Con cuchillo frontal Con cuchillo frontal & Arrastrador / 前切刀装置加后拖轮
- SC: 前メス装置付+BK-20 / With fabric trimmer & BK-20
Con cuchillo frontal & Cortador para pasadores / 前切刀装置加断带机



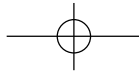

INDUSTRIAL SEWING MACHINES PRODUCTS GUIDE

DOUBLE CHAIN

DLR SERIES

DVK SERIES

NW2202 SERIES

SX SERIES

HDX SERIES

DVK1702PMD



2本針下面飾りゴム付け用ミシン

2 needle, flatbed, bottom cover stitch machine for attaching elastic.

Maquina de 2 agujas con recubridor inferior para pegar elasticos.

双针下装饰用松紧带缝纫机
(带送松紧带装置)



MODEL	No. of Needle	No. of Thread	Needle Type		Gauge (Inch)	No. of Stitch (Stitch/Inch)	Diff. Feed Ratio	Presser Foot Lift (mm)	Needle Bar Stroke (mm)	Max. Speed (rpm)
			Organ (#)	Schmetz (Nm)						
DVK1702P	2	3	UYx128GAS 11	UYx128GAS 75	1/8, 5/32, 3/16, 7/32, 1/4	8~16		8	31	4500
DVK1702PMD	2	3	UYx128GAS 11	UYx128GAS 75	1/8, 5/32, 3/16, 7/32, 1/4	8~16		8	31	4500

B2000C



2本針、前メス付ベルトループミシン

2 needle, flatbed, making belt loop machine with front fabric trimmer.

2 agujas, para fabricar pasadores, con cuchillo frontal.

双针、双重环缝带前剃刀、裤耳环缝纫机

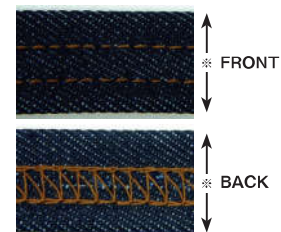

※ loop size 8mm ~ 18mm

MODEL	No. of Needle	No. of Thread	Needle Type		Gauge (Inch)	No. of Stitch (Stitch/Inch)	Diff. Feed Ratio	Presser Foot Lift (mm)	Needle Bar Stroke (mm)	Max. Speed (rpm)
			Organ (#)	Schmetz (Nm)						
B2000C (DVK1702BK)	2	3	UYx128GAS 14	UYx128GAS 90	3/16, 7/32, 1/4	9~12		8	34	4500
B2000PC (DVK1702PBK)	2	3	UYx128GAS 14~16	UYx128GAS 100	3/16, 7/32, 1/4	9~12		8	34	4500

※ベルトループ用標準サイズフォルダーは1/4"ゲージ時は12mmで7/32", 3/16"時は10mmが付いています。

※Either the folder size 12mm for 1/4" gauge or 10mm for 7/32", 3/16" is equipped as standard attachment.

※带有裤环用标准拉筒1/4" - 12mm巾、7/32", 3/16" - 10mm巾。

OTHER TECHNICAL DATA 仕様明細

MODEL	No. of Needle	No. of Thread	Needle Type		Gauge (Inch)	No. of Stitch (Stitch/Inch)	Diff. Feed Ratio	Presser Foot Lift (mm)	Needle Bar Stroke (mm)	Max. Speed (rpm)
			Organ (#)	Schmetz (Nm)						
DVK1702B	2	3	UYx128GAS 14~16	UYx128GAS 100	3/16, 7/32, 1/4	9~12		8	34	4500
DVK1702MLH	2	3	UYx128GAS 16	UYx128GAS 100	1/8	8~16		8	31	4000

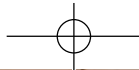

NW2202 SERIES

NW2202シリーズは、フラットベッド2本針片面縫、前メス付きベルトループ縫い用マシンです。B2000Cを更に改良した新モデルです。新モデルは

- ① 補助押えが主押えに対して独立式になり取り外しが簡単で、ストップバー機能が付き、縫い始めの生地入れフォルダーの位置合わせが非常に容易になりました。
- ② 下メス調整ダイヤル機構により左右メスのバネ圧が均一に調整でき、生地を確実にカットします。
- ③ 上記2)の下メス位置ダイヤル式微調整機構により、メス合わせも簡単になり仕上がりループ幅は8~20mmまでが可能で、ループ幅16mm以上の場合には針板、送り歯幅も広くなり広範囲な製品に対応できます。

NW2202 series is a flatbed, 2 needle, bottom cover stitch machine for belt loop making with front knives. It is a new model which has further improvement of B2000C.

New features are;

- ① The support (front) presser foot is independent against main presser foot, so that it is easily detached and also it has a stopping function to keep at lifting position. Therefore, it is extremely easy for the positioning of folder when starting to sew.
- ② Equipped with new adjusting dial of lower knives.
Both spring pressure of right and left lower knives can be equally adjusted by this dial.
- ③ Adjusting knob enables you to fine-tune the cutter easily and produce belt loops from 8mm up to 20mm.
For the width over 16mm, the special wide needle plate and feed dog are available.

Las series NW2202 es una cama plana, 2 agujas, cobertor de puntada de fondo, maquina para hacer pasador con cuchilla delantera. Es un nuevo modelo que tiene otra mejora de B2000C.

Las nuevas características son;

- ① El(delantero) prensa tela de soporte es independiente contra el prensa tela principal, por lo que se remueve facilmente y tambien tiene una funcion de para para mantener en una posicion de levantamiento.
Por lo tanto, es extremadamente facil para el posicionamiento del folder cuando se inicia la costura.
- ② Equipada con nuevos ajustes de indicador para las cuchillas inferiores que pueden ser ambas ajustadas con la, presion del resorte de la cuchillas inferiores(izquierda y derecha) igualmente, para que asi puedan cortar seguramente la tela.
- ③ Facil ajuste de las cuchillas superiores e inferiores. Capacidad para fabricar de 8-20mm por lo mencionado anteriormente(No.2) el nuevo ajuste del indicador de la cuchilla inferior y el ancho de los pasadores como tamano final.
En caso de aumentar a 16mm, el tamano del ancho de la plancha y el diente estan disponibles como opcion. Por lo tanto, las series BLX tienen un amplio rango de operaciones para fabricar varios tamanos de pasadores.

NW2202 系列是平台式 2 针单面绷缝，前切刀裤耳环缝的缝纫机。

DVK 系列 B-2000C 的改良后的新型号：

新型号：① 补助压脚和主压脚分开，容易取出和装上，带停位，开始缝时进布和卷边器位置调整很容易。

② 旋转钮可调整左、右下切刀的压力，保证切布料的均等。

③ 按钮式调整缝迹长度。

NW2202シリーズ モデル表示方法

NW22

シリーズ名
SERIES NAME
NOMBRE DE SERIE
系列名称

02

針数
NEEDLES
AGUJAS
针数

02:2本針 / 2 needle
2 AGUJAS / 2针

G

Gグレード
Ggrade
G級

C

プーラー / PULLER
ARRASTRADOR / 后拖轮

- C: 前メス付
With fabric trimmer
Con cuchillo frontal
装有前刀
- PC: 前メス装置付+プーラー
With fabric trimmer & Puller
Con cuchillo frontal y arrastrador
前切刀装置加后拖轮



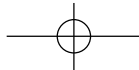

INDUSTRIAL SEWING MACHINES
PRODUCTS GUIDE

DOUBLE CHAIN

DLR SERIES

DVK SERIES

NW2202 SERIES

SX SERIES

HDX SERIES

NW2202GC

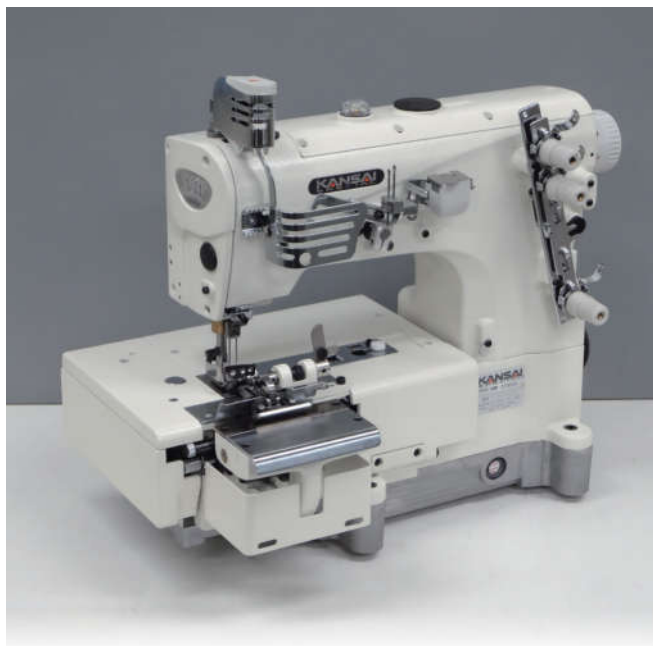

フラットベッド2本針片面飾り、前メス付き
ベルトループ用マシン

2 needle, flatbed, bottom cover
stitch, beltloop making machine
with front trimmer.

2 agujas, recubridor inferior, para
la fabricacion de pasadores con
cortador frontal.

双针、双重环缝带前刮刀、裤耳环用缝纫机

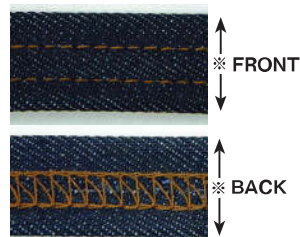

※loop size 8mm~20mm

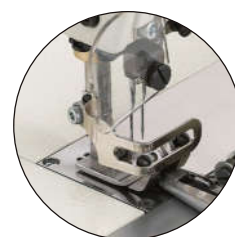

NW2202GPC



フラットベッド2本針片面飾り、前メス、
プラー付きベルトループ用マシン

2 needle, flatbed, bottom cover
stitch, beltloop making machine
with front trimmer and puller.

2 agujas, recubridor inferior, para
la fabricacion de pasadores con
cortador frontal y arrastrador.

双针裤耳机附属后拉

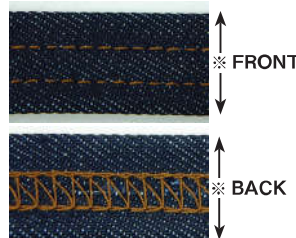

※loop size 8mm~20mm



MODEL	No. of Needle	No. of Thread	Needle Type		Gauge (Inch)	No. of Stitch (Stitch/Inch)	Diff. Feed Ratio	Presser Foot Lift (mm)	Needle Bar Stroke (mm)	Max. Speed (rpm)
			Organ (#)	Schmetz (Nm)						
NW2202GC NW2202GPC	2	3	UY×128GAS 14~16	UY×128GAS 100	3/16,7/32,1/4,1/4W	6~12		8	31	4500

※ベルトループ用標準サイズフォルダーは1/4"ゲージ時は12mmで7/32",3/16"時は10mmが付いています。

※Either the folder size 12mm for 1/4" gauge or 10mm for 7/32",3/16" is equipped as standard attachment.

※带有裤环用标准拉筒1/4" - 12mm巾、7/32"、3/16" - 10mm巾。

※NW2202GC/NW2202GPC 1/4"WはBLX2202CW 1/4"の後継機です。

※NW2202GC/NW2202GPC 1/4"W is the successor model of BLX2202CW 1/4".

※Antiguo BLX2202CW 1/4" ⇒ Nuevo NW2202GC 1/4"W

※NW2202GC/NW2202GPC 1/4" W是BLX2202CW 1/4" 的改良后的新型号。

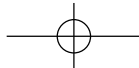

SX SERIES

SXは送り出し腕型3本針二重環縫いミシンです。

ジーンズやワーキングウェアの股縫い、脇縫いなど各種厚物生地のコ巻き縫い(ラップシーム)用ミシンです。

厚物地に最適な上ローラーと差動送り機構により左右の生地がずれることなく正確に送られ、股下部の縫い合わせなどのような段部の箇所もスムーズに縫製することができます。

SX series is a 3 needle feed-off-the-arm, double chain stitch machine with upper puller. Suitable for lap seaming or side seaming on heavy weight fabrics such as jeans and working pants.

Major features help to feed the fabric uniformly so that the machine can inseam jeans even at the cross seam sections. Puckering is no longer your concern.

SX series es 3 agujas doble cadeneta-puler. Para materiales pesados, jeans, ropa de torabajo, equipada con un empujador en la parte superior para el puler, mecanismo diferencial, y poder alimentar telas pesadas, con puntadas correctas, incluyendo donde se unen varios pliegue de tela.

SX 系列为伸臂式 3 针双重链缝的缝纫机, 适合于牛仔工作服的内侧缝, 肋下缝等各种厚料的双卷边缝的上拖轮和差动送布来防止布料的股下部分缝绉时的偏差, 保证缝绉质量。

SXシリーズ モデル表示方法

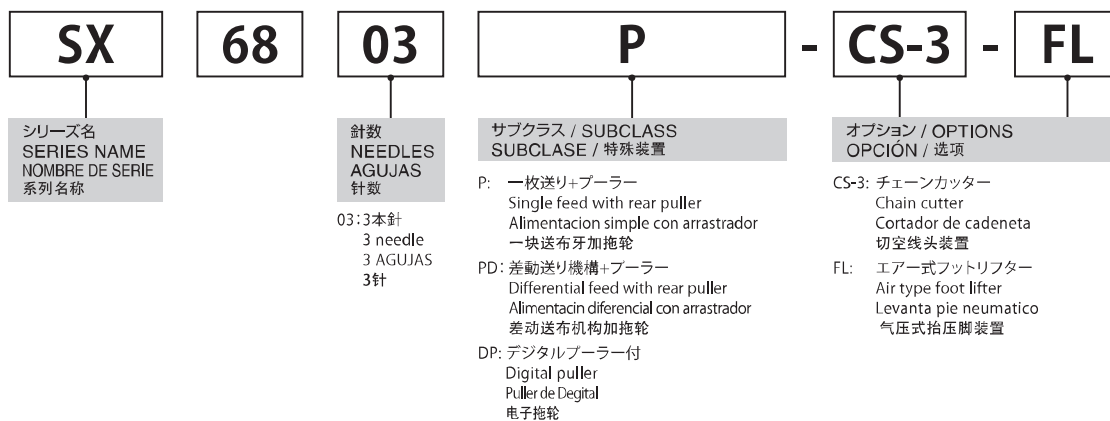

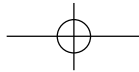

INDUSTRIAL SEWING MACHINES PRODUCTS GUIDE

DOUBLE CHAIN

DLR SERIES

DVK SERIES

NW2202 SERIES

SX SERIES

HDX SERIES

SX6803PD



送り出し腕型3本針2重環縫い
ラップシーム用マシン

3 needle, feed-off-the-arm double
chain stitch machine for lap seaming.

Camá de brazo, 3 agujas, doble
cadeneta con mecanismo
diferencial.

伸臂式 3 针 2 重链缝 1 个送布牙

SX6803PD-DP



MODEL	No. of Needle	No. of Thread	Needle Type		Gauge (Inch)	No. of Stitch (Stitch/Inch)	Diff. Feed Ratio	Presser Foot Lift (mm)	Needle Bar Stroke (mm)	Max. Speed (rpm)
			Organ (#)	Schmetz (Nm)						
SX6803PD	3	6	TVX3 21	UY × 128GAS 130	1/4, 9/32	6~12	0.7~1.3	8	33.3	4500
SX6803P	3	6	TVX3 21	UY × 128GAS 130	1/4, 9/32	6~12	/	8	33.3	4500
SX6803PD-DP	3	6	TVX3 21	UY × 128GAS 130	1/4, 9/32	6~12	0.7~1.3	8	33.3	3500
SX6803P-DP	3	3	TVX3 21	UY × 128GAS 130	1/4, 9/32	6~12	/	8	33.3	3500

- ※ SX6803DP-PDはダイレクト式サーボモーター、テーブル、スタンド、エア式押上げ装置付
- ※ SX6803DP-PD are including direct servo motor, table, stand, air foot lifter.
- ※ SX6803DP-PD es incluido motor directo, tabla, pata, y levanta-pie de tipo aire.
- ※ SX-6803DP/FL 是直驱式的伺服马达，配有机架台板，气动式抬压脚装置



HDX SERIES

HDXシリーズは、極厚物用のフラットベッド1本針、2本針二重環縫いマシンです。
 DVKシリーズのモデルDVK1701EHDを更に改良したモデルです。
 針棒ストロークは48mm、水平上下運動の新送り機構を採用し、送り量は最大15mm、押え上げ量12mmという、袋縫い専用モデルです。

HDX series is flatbed, 1 or 2 needle double chain stitch machine for sewing heavy materials. It is a new model which has further improvement of DVK1701EHD. Needle stroke is 48mm. HDX series is a specialized model for Bag Forming which is equipped with max. feeding amount 15mm and 12mm height of the presser foot lift, due to the innovation of new developed feed mechanism with horizontal and up-down movements.

La serie HDX con 1 aguja, cama plana, doble cadeneta, para coser en materiales pesados, este nuevo modelo viene con adelantos referente a la maquina DVK1701EHD, el golpe de aguja es de 48mm, la serie HDX es un modelo exclusivo para la formacion de bolsas. Una alimentacion maxima de 15mm un levantado del pie de 12mm, debido al nuevo desarrollado mecanismo de alimentacion horizontal y de arriba y abajo.

HDX系列为超厚料缝平台式1针双重环缝绉机。
 DVK系列的DVK-1701EHD上改良的新型号。
 针棒行程48mm，水平上下运动新的送布机构。
 送布量最大15mm，压脚抬高12mm用于缝各种袋。

HDXシリーズ モデル表示方法

HDX

シリーズ名
 SERIES NAME
 NOMBRE DE SERIE
 系列名称

11

01

針数
 NEEDLES
 AGUJAS
 针数

01:1本針
 1 needle
 1 agujas
 1针
 02:2本針
 2 needle
 2 agujas
 2针

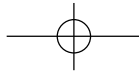

INDUSTRIAL SEWING MACHINES PRODUCTS GUIDE

DOUBLE CHAIN

DLR SERIES

DVK SERIES

NW2202 SERIES

SX SERIES

HDX SERIES

HDX1101

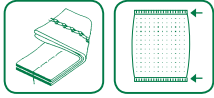

1本針二重環極厚物縫いマシン

1 needle, flatbed, double chain stitch machine for ultra heavy fabrics.

1 aguja doble cadeneta para material extra pesado.

单针双圈链锁线迹的极厚织物用缝纫机

MODEL	No. of Needle	No. of Thread	Needle Type		Gauge (Inch)	No. of Stitch (Stitch/Inch)	Diff. Feed Ratio	Presser Foot Lift (mm)	Needle Bar Stroke (mm)	Max. Speed (rpm)
			Organ (#)	Schmetz (Nm)						
HDX1101	1	2	DR X 2 25	DR X 2 200	1/4"	2~4	1/2	12	48	3000

HDX1102

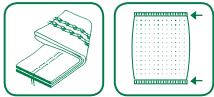

FRONT



BACK



2本針二重環極厚物縫いマシン

2 needle, flatbed, double chain stitch machine for ultra heavy fabrics.

2 agujas doble cadeneta para material extra pesado.

双针缝袋机式缝纫机，用于厚料

MODEL	No. of Needle	No. of Thread	Needle Type		Gauge (Inch)	No. of Stitch (Stitch/Inch)	Diff. Feed Ratio	Presser Foot Lift (mm)	Needle Bar Stroke (mm)	Max. Speed (rpm)
			Organ (#)	Schmetz (Nm)						
HDX1102	2	4	UY X 143GS 25		1/4"	2~4	1/2	12	48	3000

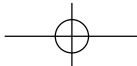

DFB SERIES

DFBシリーズは、フラットベッド多本針二重環縫いミシンです。ゴム付け、ゴム入れ、前立て縫い、ライン付け、腰帯付けやスマッキング、シャーリングなど下着、スポーツウェア、婦人服、室内装飾品に至るまで汎用性に優れたモデルです。
ルーパー縦振り機構のため、2~21本針までゲージの種類も多く、針数も製品に合わせて選んでいただけます。

DFB series are flatbed, multi-needle double chain stitch machines. This series is multi-purpose such as attaching elastic, attaching waistband, sewing the front of shirts, attaching line tapes, smocking and shirring, etc., which are ideal for under wear, sports wear, lady's wear, interior decorated goods (curtains, table cloths, etc.). There are 2 up to 21 needle available due to vertical movement of the looper and also many kinds of gauges which are selectable according to your needs.

Cama plana multiagujas, doble cadeneta extremadamente versatile, para adaptar elastico, frente de camisa, puntadadecorativa y pliegues, ideal para ropa interior, ropa deportiva, corinas, manteles, etc. Movimiento del garfio vertical, de 2 a 21 agujas con diferentes medidas para su necesidad.

DFB 系列为平台式多针机。上松紧，门襟，滚条，上腰，装饰缝等用于内衣，运动服，妇女服，室内装饰品等广范围。
弯针为纵向摆动，2-21 针的各种针位可供选择。

DFB・BXシリーズ 表示方法

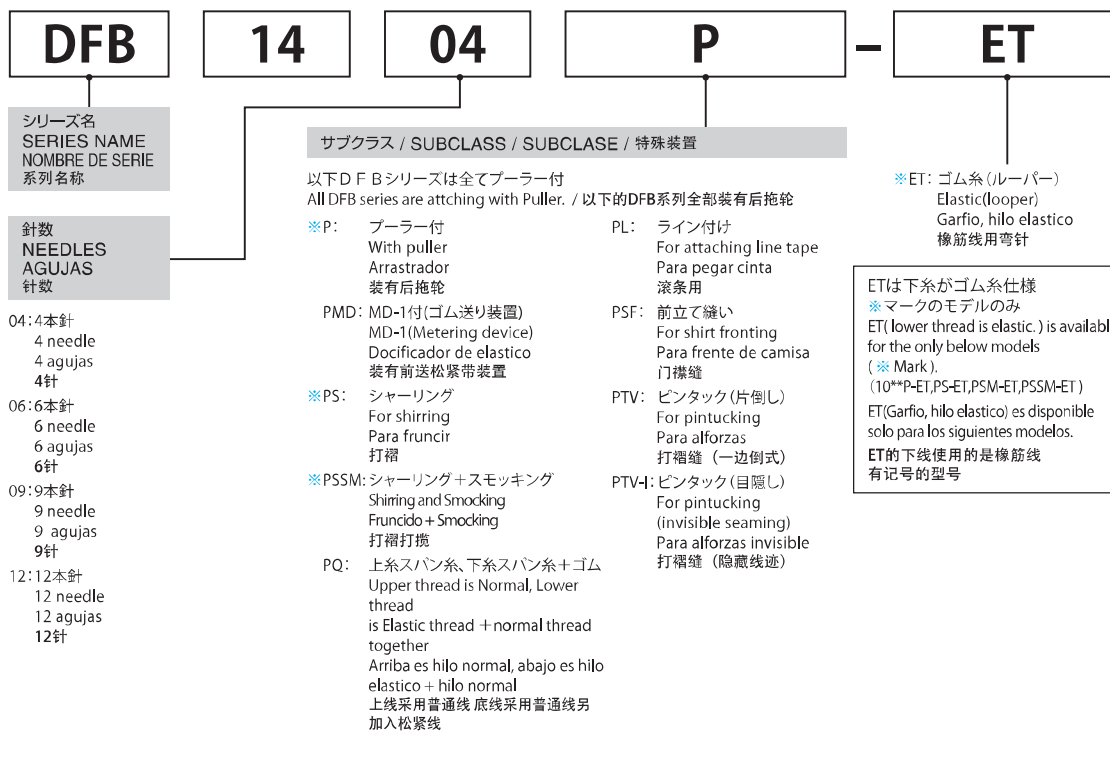

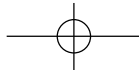

INDUSTRIAL SEWING MACHINES PRODUCTS GUIDE

MULTI-NEEDLE

DFB SERIES

NB SERIES

FX SERIES

DX SERIES

FBX SERIES

DFB1404P DFB1404PMD



DFB1404P

4本針平ベッド二重環縫いゴム付け用マシン。

4 needle, flatbed, double chain stitch machine for attaching elastic

4 agujas cama plana para pegar elastico.

4 针双重环缝上松紧带用缝纫机 (带送松紧带装置)



DFB1404PMD (with metering device)

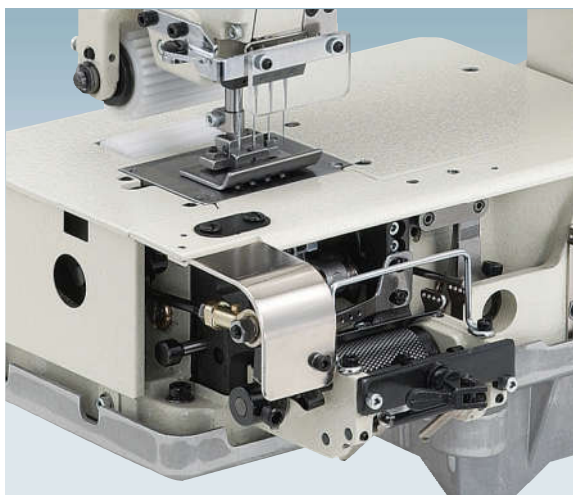

MODEL	No. of Needle	No. of Thread	Needle Type		Gauge (Inch)	No. of Stitch (Stitch/Inch)	Diff. Feed Ratio	Presser Foot Lift (mm)	Needle Bar Stroke (mm)	Max. Speed (rpm)
			Organ (#)	Schmetz (Nm)						
DFB1404P	4	8	UO×113 14	UY×113 90	3/4, 1, 1-1/8, 1-1/4, 1-1/2, 1/4-1/2-1/4	7~17		10	34	4500
DFB1404PMD	4	8	UO×113 14	UY×113 90	3/4, 1, 1-1/8, 1-1/4, 1-1/2, 1/4-1/2-1/4	8~14		10	34	4500
DFB1406P	6	12	UO×113 14	UY×113 90	3/16, 1/4, 1/3, 3/8	7~17		10	34	4500
DFB1406PMD	6	12	UO×113 14	UY×113 90	1/4	7~17		10	34	4500
DFB1408P	8	16	UO×113 14	UY×113 90	1/4	7~17		10	34	4000
DFB1408PMD	8	16	UO×113 14	UY×113 90	1/4	7~17		10	34	4000
DFB1412P	12	24	UO×113 14	UY×113 90	1/8, 3/16, 1/4, 5mm	7~17		10	34	4000
DFB1412PMD	12	24	UO×113 14	UY×113 90	3/16, 1/4	7~17		10	34	4000

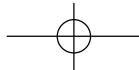

DFB1404PSF

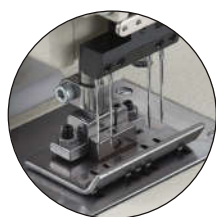
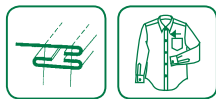

4本針前立て用マシン。
針棒ショートストロークおよび先引きローラーによりワイシャツの前立て縫いに適しています。

4 needle, flatbed multi-functional machine with smooth puller for shirt fronting.

4 agujas, para coser el frente de la camisa, equipada con arrastrador de goma.

4 针门襟用缝纫机
(由于有前导式松紧带拉料装置, 适合缝衬衫的前身片)



MODEL	No. of Needle	No. of Thread	Needle Type		Gauge (Inch)	No. of Stitch (Stitch/Inch)	Diff. Feed Ratio	Presser Foot Lift (mm)	Needle Bar Stroke (mm)	Max. Speed (rpm)
			Organ (#)	Schmetz (Nm)						
DFB1404PSF	4	8	UO×113 14	UY×113 90	3/16-3/4-3/16, 1/4-3/4-1/4, 3/16-1-3/16, 1/4-1-1/4	7~17		10	31	4500

DFB1412PL

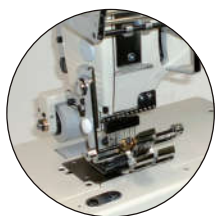

6本針二重環縫いラインテープ付け用マシン

6 needle, flatbed, double chain stitch machine for attaching line tapes.

6 agujas, maquina de cama cilindrica de doble cadeneta para pegar lineas de cinta.

6 针双重环缝, 滚条用缝纫机



MODEL	No. of Needle	No. of Thread	Needle Type		Gauge (Inch)	No. of Stitch (Stitch/Inch)	Diff. Feed Ratio	Presser Foot Lift (mm)	Needle Bar Stroke (mm)	Max. Speed (rpm)
			Organ (#)	Schmetz (Nm)						
DFB1406PL	6	12	UO×113 14	UY×113 90	1/4, 1/3, 3/8	7~17		10	34	4500
DFB1408PL	8	16	UO×113 14	UY×113 90	1/4	7~17		10	34	4000
DFB1412PL	12	24	UO×113 14	UY×113 90	1/4, 3/16	7~17		10	34	4000

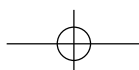

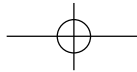

INDUSTRIAL SEWING MACHINES PRODUCTS GUIDE

DFB1403PSM-H

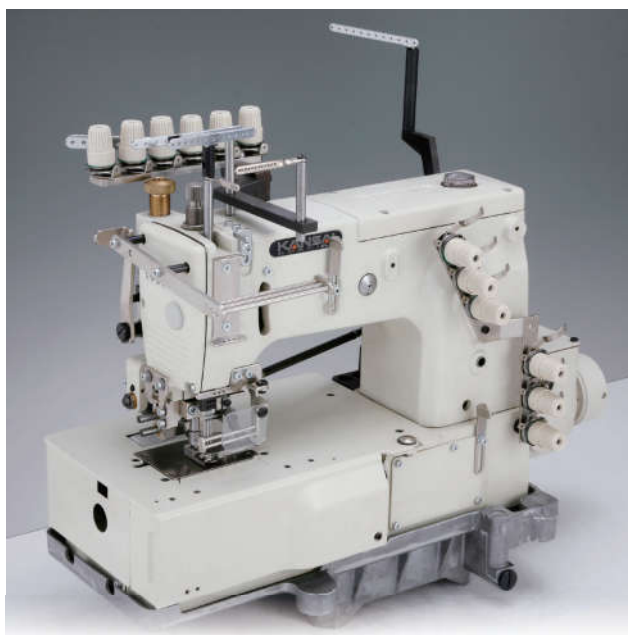

3本針二重環縫いスマッキングマシン。
6種のカムによりあらゆるデザインが可能。厚物素材に適します。

3 needle, flatbed, double chain stitch machine with 6 different smocking cams. Suitable for heavy material.

3 agujas, con puntada decorativa con 6 diferentes cams. Conveniente para material pesado.

3 针双重环饰缝纫机。
用 6 种花盘所有的设计可能。



CAM NO.8

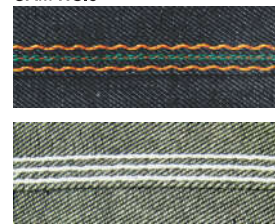

カムの種類及び模様 | Smocking Description / Descripción de Smocking / 模様盘的种类

○ ○ ○ 飾り糸ル-ハ* - (上) / Top Smocking Looper
○ ○ ○ 飾り糸ル-ハ* - (下) / Bottom Smocking Looper

カム No. CAM No.	○ ○ ○	○ ○ ○	○ ○ ○	○ ○ ○	○ ○ ○	○ ○ ○	○ ○ ○
No. 7 品番 PART No. 04-357							
No. 8 品番 PART No. 04-358							
No. 9 品番 PART No. 04-359							

○ ○ ○ 飾り糸ル-ハ* - (上) / Top Smocking Looper
○ ○ ○ 飾り糸ル-ハ* - (下) / Bottom Smocking Looper

カム No. CAM No.	○ ○ ○	○ ○ ○	○ ○ ○	○ ○ ○	○ ○ ○	○ ○ ○	○ ○ ○
No. 10 品番 PART No. 04-360							
No. 12 品番 PART No. 04-362							
No. 13 品番 PART No. 04-363							



オプションの押えに換えることによりポケットヘム縫いも可能です。
Optional presser foot can do also pocket hemming operation.
El pie opcional puede hacer tambien la operacion de dobladillo del bolsillo.
根据更换配件压脚，可以缝制口袋的折下摆缝。

MODEL	No. of Needle	No. of Thread	Needle Type		Gauge (Inch)	No. of Stitch (Stitch/Inch)	Diff. Feed Ratio	Presser Foot Lift (mm)	Needle Bar Stroke (mm)	Max. Speed (rpm)
			Organ (#)	Schmetz (Nm)						
DFB1403PSM-H	3	9	DVX57 18		1/4	7~17		6	34	2000

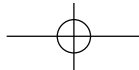

DFB1412PQ

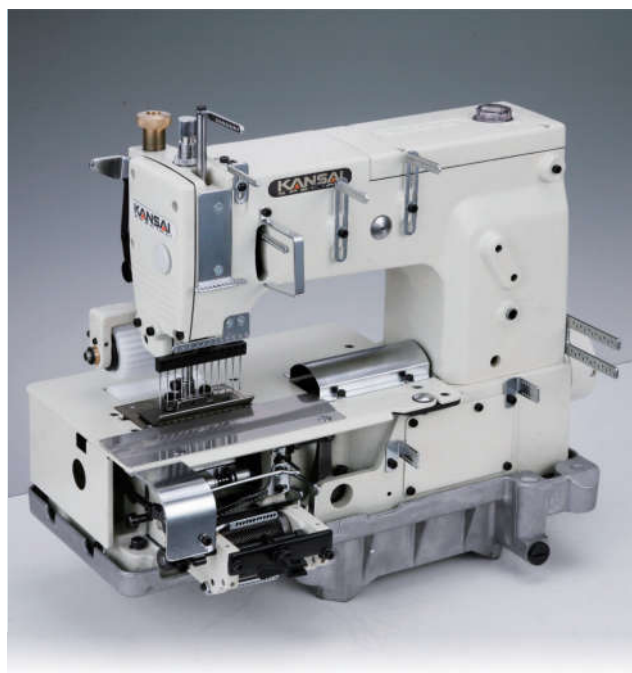
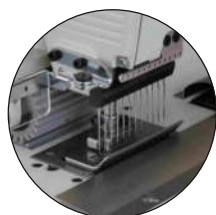

12本針二重環縫いシャーリングマシン。
上下糸ともに標準糸(スパン)を使用し、
ゴム糸を上下の糸に絡めて縫われます。

12 needle, flatbed, double chain stitch
machine for simultaneous shirring. Both
needle and looper threads are standard
(spun), and separate elastic thread is
sewn with looper thread together.

12 agujas, máquina de doble cadeneta
para fruncido. Los dos hilos de la aguja y
el looper son estándar, y el hilo elástico
se cose con hilo inferior juntos.

12针双重环装饰缝绉机
(上线采用普通线 底线采用普通线另加入
松紧线)



FRONT

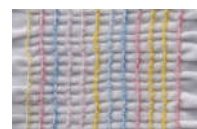

BACK

MODEL	No. of Needle	No. of Thread	Needle Type		Gauge (Inch)	No. of Stitch (Stitch/Inch)	Diff. Feed Ratio	Presser Foot Lift (mm)	Needle Bar Stroke (mm)	Max. Speed (rpm)
			Organ (#)	Schmetz (Nm)						
DFB1412PQ	12	36	DVX57 14	DVX57 90	3/16, 1/4	7~17		10	34	2500

DFB1412PS
DFB1412PS-ET

12本針二重環縫いシャーリングマシン

12 needle, flatbed, double chain
stitch machine for shirring with
elastic thread use in the loopers.

Cama plena de 12 agujas para
pliegues.

12针双重环缝，打褶缝绉机



FRONT

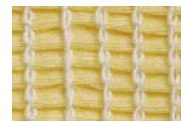

BACK

MODEL	No. of Needle	No. of Thread	Needle Type		Gauge (Inch)	No. of Stitch (Stitch/Inch)	Diff. Feed Ratio	Presser Foot Lift (mm)	Needle Bar Stroke (mm)	Max. Speed (rpm)
			Organ (#)	Schmetz (Nm)						
DFB1412PS	12	24	DV×57 14	DV×57 90	3/16, 1/4	7~17		10	34	4000
DFB1412PSET	12	24	DV×57 14	DV×57 90	3/16, 1/4	7~17		10	34	4000

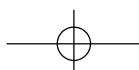

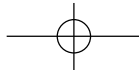

INDUSTRIAL SEWING MACHINES PRODUCTS GUIDE

MULTI-NEEDLE

DFB SERIES

NB SERIES

FX SERIES

DX SERIES

FBX SERIES

DFB1412PSSM-ET

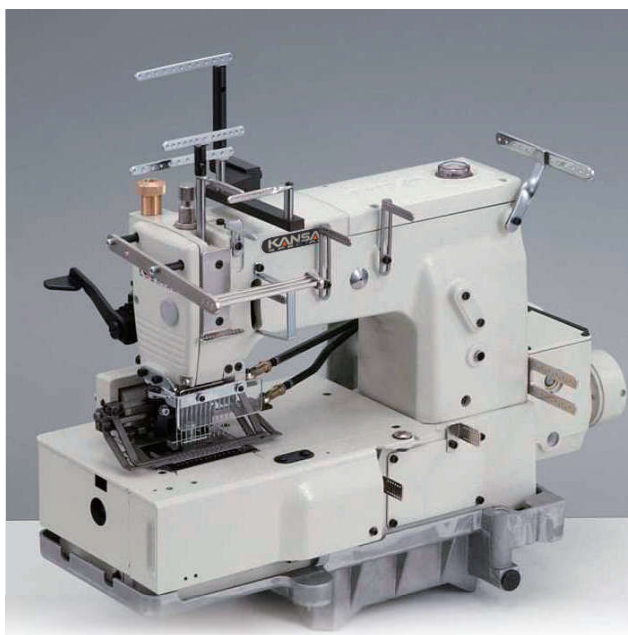
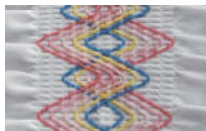

12本針2重環縫いスモッキング・シャーリングマシン

12 needle, flatbed double chain stitch machine for shirring and smocking with elastic thread inside the loopers.

12 agujas, con puntada decorativa y alforzas, el hilo elastico para looper.

12针双重环缝，打褶打紧缝纫机



MODEL	No. of Needle	No. of Thread	Needle Type		Gauge (Inch)	No. of Stitch (Stitch/Inch)	Diff. Feed Ratio	Presser Foot Lift (mm)	Needle Bar Stroke (mm)	Max. Speed (rpm)
			Organ (#)	Schmetz (Nm)						
DFB1412PSSM	12	36	DV×57 14	DV×57 90	3/16, 1/4	7~17		6	34	2000
DFB1412PSSMET	12	36	DV×57 14	DV×57 90	3/16, 1/4	7~17		6	34	2000

DFB10 series, DFB14 series ET, PQ 比較 | comparison

MODEL	THREAD		PRESSER FOOT	LOOPER	STITCH (BACK SIDE)	
	NEEDLE	LOOPER				
DFB1012P	Elastic		TYPE A (FLAT)	19-112~17		
DFB1012PS	Elastic					
DFB1012PSSM	Elastic					
DFB1412PSET	Standard	Elastic	Presser foot with 2mm, 4mm step for shirring operation	14-432 (ET用)		
DFB1412PSSMET	Standard	Elastic	TYPE D - Flat and Presser foot with 2mm step			
DFB1412PQ	Standard	Elastic + standard	TYPE E - Flat for PQ	14-431		
DFB1412PQSM	Standard	Elastic + standard	TYPE F - Flat for PQSM			

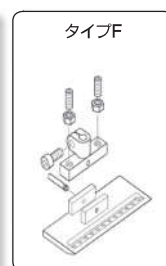
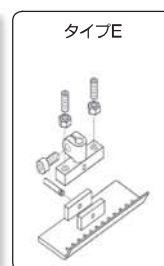
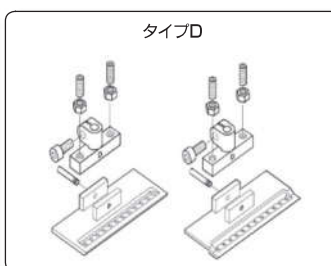
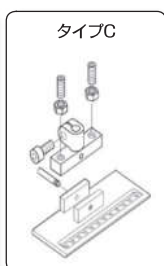
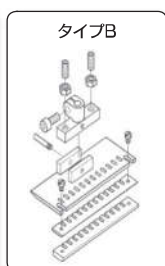
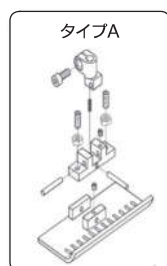

DFB1412PTV



12本針二重環縫いピンタック用マシン。タック幅は爪の交換により2mm、5mm、8mmの3種類が可能です。

12 needle, flatbed, double chain stitch machine for pin-tucking. The width of pin-tucking can be changed to 2, 5 and 8mm by changing the nail blades.

12 agujas, looper vertical, doble puntada en cadena, maquina de cama plana con accesorios para pliegues y puller.

12针双环缝链式打褶缝纫机
PTV打褶幅度通过爪的更换可加工2、5、8mm的3种规格

MODEL	No. of Needle	No. of Thread	Needle Type		Gauge (Inch)	No. of Stitch (Stitch/Inch)	Diff. Feed Ratio	Presser Foot Lift (mm)	Needle Bar Stroke (mm)	Max. Speed (rpm)
			Organ (#)	Schmetz (Nm)						
DFB1412PTV	12	24	DVX57 12	DVX57 80	3/16, 1/4	7~17		10	34	3500

■ PTV 標準仕様 / PTV standard model / PTV modelo normal / PTV modelo normal / PTV 縫明线条仔用
ビジブルタック用 / For Visible tucking / Puntada visible / Para ponto visivel / 高度加褶针明细

	ピンタック折り幅 Pin tucking width Anchura de Pin Tucking PTV打褶高度	L:左倒し用ガイド Left side fold Dobra lado izquierdo 左摺針	R:右倒し用ガイド Right side fold Dobra lado derecho 右摺針	C: 中心 Center Centro 中心
上爪 Upper guide Guia superior 喇叭上爪		13 pcs	13 pcs	1 pc
下爪 Lower guide Guia inferior 喇叭下爪	2mm	12pcs	12pcs	
	5mm	12pcs	12pcs	
	8mm	8pcs	8pcs	

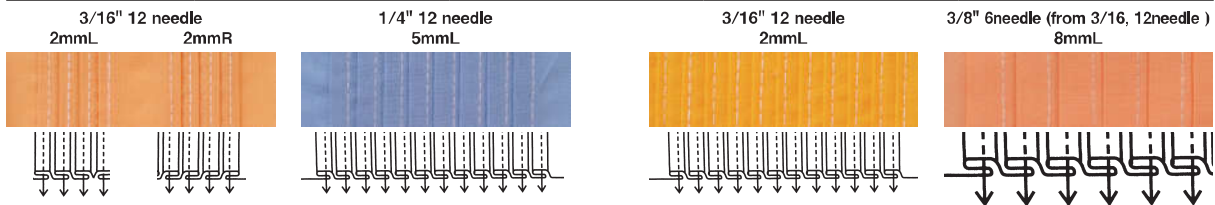

■ PTV オプション仕様 / PTV optional model / PTV modelo opcional / PTV modelo opcional / 縫暗线条仔用
PTV-I インビジブルタック用 / For Invisible tucking / Para tucking invisible / Para tucking invisivel / 仕様高度加褶针明细

	ピンタック折り幅 Pin tucking width PTV Anchura de Pin Tucking 打褶高度	ゲージ幅 Gauge size Tamano de aguja 針距	L:左倒し用ガイド L: Left side fold Dobra lado izquierdo 左摺針	押え Presser foot Prensatela 押脚
下爪 Lower guide Guia inferior 喇叭下爪	6mm	3/16"(4.8mm)	12 pcs	専用押え Exclusive presser foot for PTV-I Prensatela exclusiva para PTV-I Pressao exclusiva para PTV-I 专用押脚
	8mm	1/4" (6.4mm)	12 pcs	
	11mm	* 3/8" (9.5mm)	6 pcs	
	14mm	* 1/2" (12.7mm)	6 pcs	

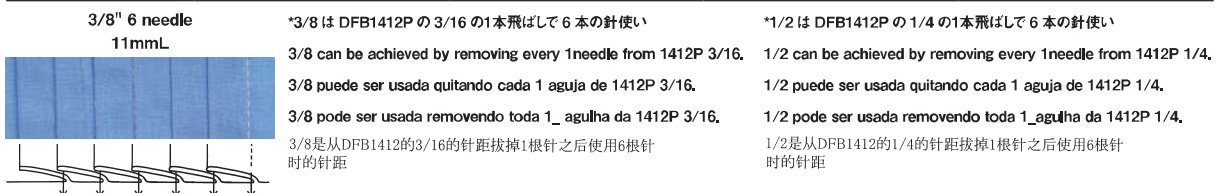

Gauge

- 多針マシン特殊ゲージ表
Special gauge description for Multi gauge machine
Descripción de tamaño de aguja especial para Multi agujas
Descrição de bitola especial para máquina Multi agulhas
多針縫纫机特殊针距表

MODEL	DFB1411P-XP	DFB1415SPF	DFB1421P	DFB1418P
ゲージ Gauge Calibre 针位				
	1/8-1/8-1/8-1/8-1/4-1/4-1/8-1/8-1/8-1/8"	1/8-1/8-1/8-1/8-1/4-1/4-1/8-1/8-1/8-1/8"	1/8"	1/8-1/8-1/8-1/8-1/4-1/8-1/8-1/4-1/8-1/8-1/8-1/8"
糸調子セット Thread tension set Unidad de tension de hilo				
	4X4	4X4	12X12	6X6
テーブルセット図外観 Overview Perspectiva 概要				
プーラー / Puller Arrastrador / 后拖轮	Nylon gear/※Rubber/*Steel gear	Steel gear /※knurling gear	Rubber	Rubber

※：※印はアクセサリBOXに同梱 Enclosed in accessory box

OTHER TECHNICAL DATA 仕様明細

MODEL	No. of Needle	No. of Thread	Needle Type		Gauge (Inch)	No. of Stitch (Stitch/Inch)	Diff. Feed Ratio	Presser Foot Lift (mm)	Needle Bar Stroke (mm)	Max. Speed (rpm)
			Organ (#)	Schmetz (Nm)						
DFB1404WB	4	8	UO×113 18	UY×113 110	3/16-3/4-3/16, 1/4-3/4-1/4, 3/16-1-3/16, 1/4-1-1/4	7~17		10	34	4500
DFB1412PQSM	12	48	DV×57 14	DV×57 90	3/16, 1/4	7~17		6	34	2000
DFB1402MR	2	4	UO×113 14	UY×113 90	1/4	7~17		10	31	3500
DFB1412MR	12	24	UO×113 14	UY×113 90	1/4	7~17		10	31	3000
DFB1012P	12	12	DVX57LE 21		3/16, 1/4	7~17		10	34	2000
DFB1012PS	12	12	DVX57LE 21		3/16, 1/4	7~17		10	34	2000
DFB1012PSSM	12	24	DV-K25 21		3/16, 1/4	7~17		6	34	2000

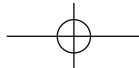

NB SERIES

NBシリーズは、フラットベッド多本針二重環縫いミシンです。ゴム付け、ゴム入れ、前立て縫い、ライン付け、腰帯付けやスマッキング、シャーリングなど下着、スポーツウェア、婦人服、室内装飾品に至るまで汎用性に優れたモデルです。

ルーバー縦振り機構のため、25,33本針までゲージの種類も多く、針数も製品に合わせて選んでいただけます。また、BXの後継機として新たに加わったNBシリーズは、従来の25本針および33本針仕様はそのままに、デザインを一新、明るくスマートな外観に生まれ変わりました。さらにスマッキング用モデルのPSM、PSSMでは飾り糸振りを4段とし、さらに多様なスマッキングが可能になりました。

NB series are flatbed, multi-needle double chain stitch machines. This series is multi-purpose such as attaching elastic, attaching waistband, sewing the front of shirts, attaching line tapes, smocking and shirring, etc., which are ideal for under wear, sports wear, lady's wear, interior decorated goods (curtains, table cloths, etc.). There are 25,33 needle available due to vertical movement of the looper and also many kinds of gauges which are selectable according to your needs.

Just recently, KANSAI SPECIAL launched the "NB Series", the new model of BX Series. This NB Series has a newly shaped, modern casting. The smocking models PSM & PSSM are now equipped with 4 spreaders for the decorative threads. This innovation enables a greater variety of different designs.

Cama plana multiagujas, doble cadeneta extremadamente versatil, para adaptar elastico, frente de camisa, puntadadecorativa y pliegues, ideal para ropa interior, ropa deportiva, cortinas, manteles, etc. Movimiento del garfio vertical, de 25,33 agujas con diferentes medidas para su necesidad.

NB 系列为平台式多针机。上松聚，门襟，滚条，上腰，装饰缝等用于内衣，运动服，妇女服，室内装饰品等广范围。弯针为纵向摆动，25,33 针的各种针位可供选择。

NB・BXシリーズ 表示方法

NB	14	33	P	ET	MD
シリーズ名 SERIES NAME NOMBRE DE SERIE 系列名称	縫目形式 SEAM TYPE TIPO DE LA COSTURA 线迹形式	針数 NEEDLES AGUJAS 针数	サブクラス&オプション SUBCLASS & OPTION SUBCLAS Y OPCION 特殊装置和附属品	メタリングデバイス Metering Device	
	14:二重環縫い Double chain stitch Puntada de la cadena doble 双重环缝 10:単環縫い Single chain stitch Sola puntada de la cadena 单环缝(只有上线没有下线)	25:25本針 25 needle 25 agujas 25針 33:33本針 33 needle 33 agujas 33針	以下BX,NBシリーズは全てプーラー付 All NB & BX models are equipped with a rear puller 以下のBX,NB系列全部装有后拖轮 ※P: プーラー付 With puller Con arrastrador 装有后拖轮 ※PS: シャーリング For shirring Para el shirring 打褶 ※PSSM: シャーリング&スマッキング For shirring & smocking Para el shirring, smocking 打褶打搅 PTV: ピンタック(片倒し) For pintucking Para el pintucking 打褶缝(一边倒式) PTV-I: ピンタック(目隠し) For pintucking (invisible seaming) Para el pintucking (cosiendo invisible) 打褶缝(隐藏线迹)	※ET: ゴム糸(ルーバー) Elastic(looper) Garfio, hilo elastico 橡筋线用弯针	ETは下糸がゴム糸仕様 ※マークのモデルのみ ET(lower thread is elastic.) is available for the only below models (※Mark). (10**P-ET,PS-ET,PSM-ET,PSSM-ET) ET(GARFIO, HILO ELASTICO) es disponible solo para los siguientes modelos. ETの下糸使用的是橡筋线有记号的型号

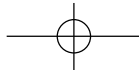
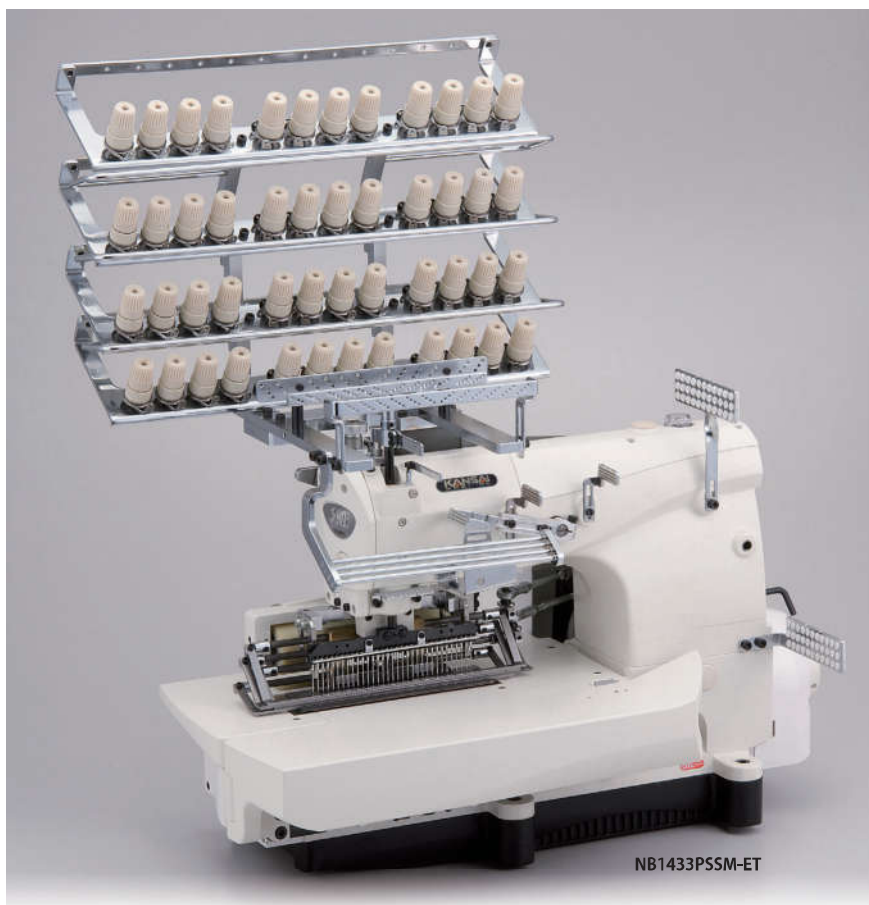
INDUSTRIAL SEWING MACHINES
PRODUCTS GUIDENB1433PSSM-ET
NB1433PSSM-ET-MD

NB1433PSSM-ET

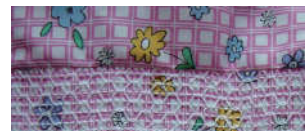
33本針ゴム糸シャーリング+スモッキング
マシン33 needle, flatbed double chain
stitch machine for shirring and
smocking with elastic thread
inside the loopers.33 agujas, con puntada decorativa
y alforzas, el hilo elastico para
looper.3 3 针平台式双重环装饰用打褶打缆缝纫
机。外观一新, 实现了更多样的装饰图案NB1433PSSM-ET-MD
(with metering device)

■ 4段のスプレッターで更なるデザインが可能に。
4 spreaders for the decorative
thread increase the number of
design patterns.
4 esparcidor de decoracion
puede aumentar mas un buen
deseno.
4段打攪条可任意变换装饰线样式。

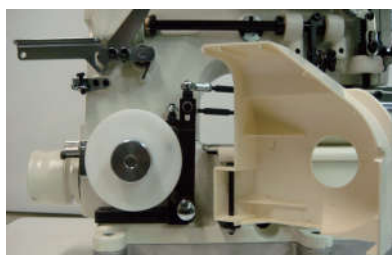







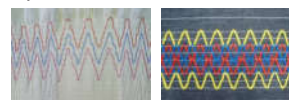

■ CAMのカバーの開け閉めが簡単になり
工具無しでスムーズなCAM交換が可能です。
The cam cover is easily openable
& closable. The cam is easily
changeable without tools!!
Se puede abrir la cubierta de leva
con facilidad, y cambiar la leva sin
herramienta.
模様盤の开关外壳无需用工具便可简单
更换。



■ レバー調節での部分シャーリングが可能に。
Lever-type adjustment enables
to make partial shirring.
Es posible hacer el fruncido
parcial como se quiera mediante
el ajuste de palanca.
调解拉杆可使打搅部分化。



MODEL	No. of Needle 	No. of Thread 	Needle Type		Gauge (Inch) 	No. of Stitch (Stitch/Inch) 	Diff. Feed Ratio 	Presser Foot Lift (mm) 	NeedleBar Stroke (mm) 	Max. Speed (rpm) 
			Organ (#)	Schmetz (Nm)						
NB1433PSSM-ET NB1433PSSM-ET-MD	33	110	DV×57 14	DV×57 90	3/16	4~18	—	6	34	2000

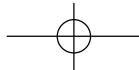

NB1033PSSM



33本針単環ゴム糸用スモッキングマシン

33 needle, flatbed, single chain stitch machine for simultaneous shirring and smocking. Needle (upper) thread : Elastic. No looper (lower) thread.

33 agujas garfios verticales, una cadeneta, cama plana, para pliegues y puntada decorativa, con arrastrador.

33 针单环打摺打搅缝纫机

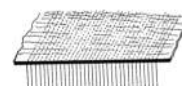

FRONT

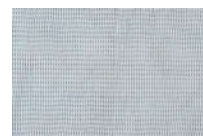

BACK

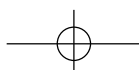
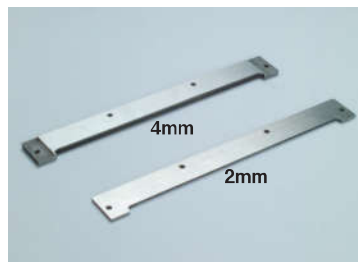

NB1433PQSM



33本針二重環縫いシャーリング・スマッキングマシン
上下糸にスパン糸を使用し、下糸にゴム糸を絡めています。

33 needle flatbed, double chain stitch machine for simultaneous shirring & smocking with our patented PQ mechanism.

33 agujas, maquina de puntada de cadena doble para el shirring del simyltanues & los smocking patentaron el mecanismo de PQ

3 3 针双重环缝，打褶打缝缝纫机
(上线用普通线 下线用普通线加松紧线)

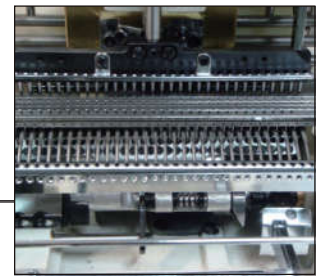

■ PQの縫製品の伸縮性

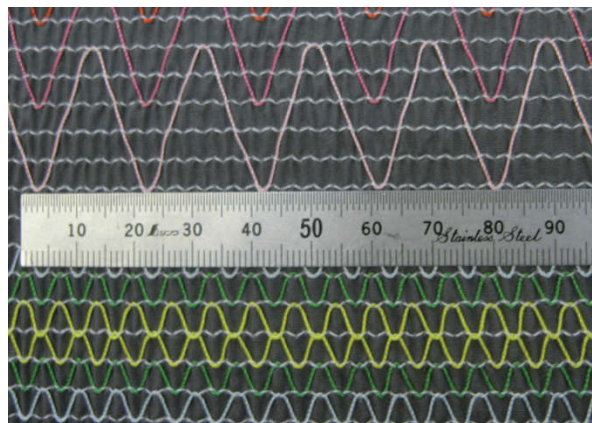
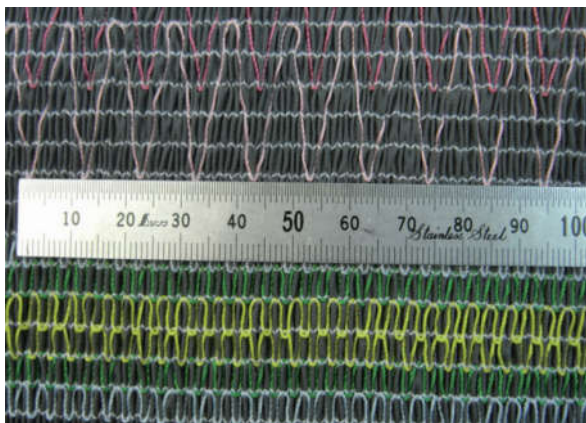

● PQで縫製した製品は強度もあり単環(10-ET)、二重環(ET)よりも伸縮性があります。

The products sewn by PQ are stronger and more stretchable than by Single chain (10-ET) and Double chain stitch (ET).

Los productos que en cosido por PQ es más fuerte y más stretchable que la Sola cadena (10-ET) y cadena Doble puntada (ET).

使用Pq縫制出来的产品既有单环的强度，又有二重环的伸缩性。

MODEL	No. of Needle	No. of Thread	Needle Type		Gauge (Inch)	No. of Stitch (Stitch/Inch)	Diff. Feed Ratio	Presser Foot Lift (mm)	Needle Bar Stroke (mm)	Max. Speed (rpm)
			Organ (#)	Schmetz (Nm)						
NB1433PQSM	33	132	DV×57 14	DV×57 90	3/16	4~18	—	6	34	2000

標準カムデザイン | PSSMカムデザイン |

CAM DESIGN FOR PSSM / PLAN DE LA LEVA PARA PSSM / 打褶打攪用模様盤

標準カムデザイン (NO.1~9) STANDARD CAM DESIGN (NO.1~9)

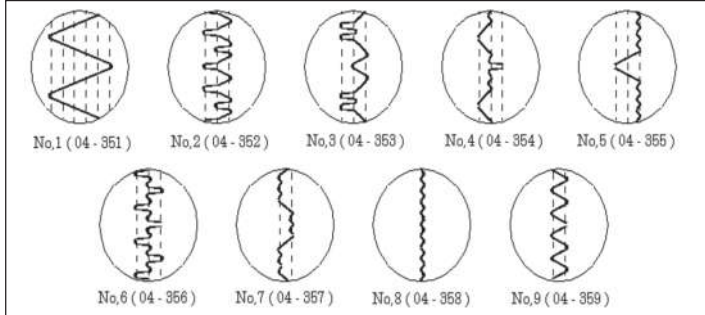

オプションカムデザイン OPTIONAL CAM DESIGN

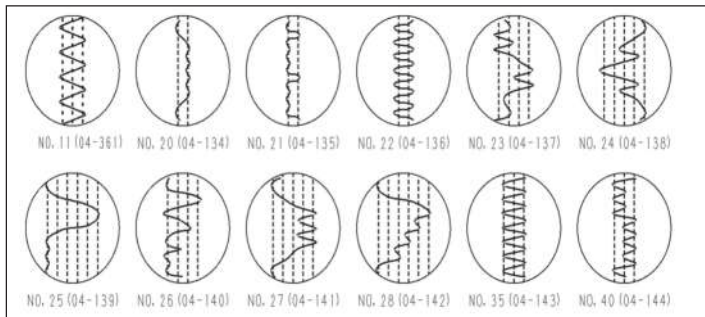

IBX, NB SERIES TECHNICAL DATA 仕様明細

	No. of Needle	No. of Thread	Needle Type		Gauge (Inch)	No. of Stitch (Stitch/Inch)		Presser Foot Lift (mm)	Needle Bar Stroke (mm)	Max. Speed (rpm)
			Orgen (#)	Schnetz (Nm)		BX	NB			
NB1425P	25	50	DV×57 14	DV×57 90	1/4	8~16	4~18	10	34	2500
NB1425PSSM	25	94	DV×57 14	DV×57 90	1/4	7~17	4~18	NB-8	34	2000
NB1433P	33	66	DV×57 14	DV×57 90	3/16	7~17	4~18	10	34	2500
NB1433PSSM	33	110	DV×57 14	DV×57 90	3/16	7~17	4~18	NB-8	34	2000
NB1025P	25	25	DV×57LE 21		1/4	7~17	4~18	10	34	2500
NB1025PSSM	25	69	DV×57LE 21		1/4	7~17	4~18	NB-8	34	2000
NB1033PSSM	33	69	DV×57LE 21		3/16	8~16	4~18	NB-8	34	2000
NB1425PSET	25	50	DV×57 14	DV×57 90	1/4	7~17	4~18	10	34	2500
NB1425PSSMET	25	94	DV×57 14	DV×57 90	1/4	7~17	4~18	NB-8	34	2000
NB1433PSET	33	66	DV×57 14	DV×57 90	3/16	7~17	4~18	10	34	2500
NB1433PSSMET	33	110	DV×57 14	DV×57 90	3/16	7~17	4~18	NB-8	34	2000
NB1425PTV	25	50	DV×57 12	DV×57 80	1/4	7~17	4~18	10	34	2500
NB1433PTV	33	66	DV×57 12	DV×57 80	3/16	7~17	4~18	10	34	2500
NB1425PQ	25	75	DV×57 14	DV×57 90	1/4		4~18	8	34	2000
NB1433PQ	33	99	DV×57 14	DV×57 90	3/16		4~18	8	34	2000
NB1425PQSM	25	119	DV×57 14	DV×57 90	1/4		4~18	8	34	2000
NB1433PQSM	33	143	DV×57 14	DV×57 90	3/16		4~18	8	34	2000

【NBシリーズの糸立てセットアップ方法】

HOW TO SET UP THREAD STAND OF NB SERIES / COMO PONER PORTA-HILO DE SERIE NB / NB系列线架的安装方法

■ THREAD STAND

MODEL	A	B	C	D	E
NB14 × P	○				
NB14 × PTV	○				
NB14 × PSSM	○			○	
NB14 × PSSMET		○		○	
NB14 × PSET		○			
NB14 × PQ	○				○
NB14 × PQSM	○			○	○
NB10 × PSSM			○	○	

A: 標準
STANDARD

B: 下糸ゴム用(ET)
FOR LOWER
THREAD (ET)

C: 単環用(上糸ゴム)
FOR SINGLE CHAIN STITCH
(UPPER THREAD)

D: 飾り糸用
FOR DECORATIVE
THREAD

E: 中間ゴム糸用(PQ)
FOR ELASTIC THREAD FOR PQ

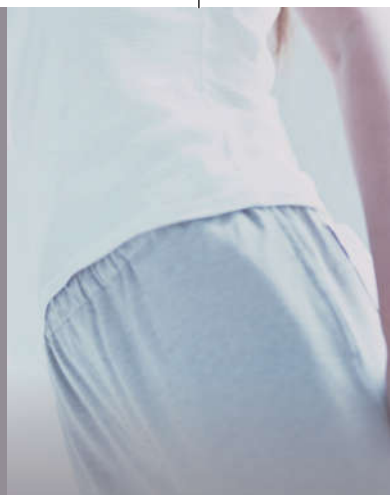
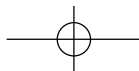

FX SERIES

FXシリーズは、シリンダーベッド、4～21本針、ルーバー縦振りの高速二重環縫いマシンです。トレーニングウェア、パジャマ、トラックス、スウェットパンツなどのゴム付けからライン付けまで種々の用途に応用できます。ゴム張り装置、エア式開閉フォルダ、糸切り装置もサブモデル、オプションとしてご利用いただけます。またエア式糸切り装置は当社独自の設計による機構で、二つのシリンダーを用いており、確実に糸をカットし、糸残りも非常に短く生産性を大幅に向上させます。またシリンダーベッドの外径は420mmで、子供服などの丸ゴム付けも行えます。

FX series is a versatile multi-needle, cylinder bed, double chain stitch machine with vertical looper movement mechanism. It can be used for attaching elastic and line tape to sweat pants, pajamas, trunks and similar garments. Major features of this series are the wide range of available gauge size (4~21 needle), cylinder bed (420mm in circumference), elastic guide rollers and KANSAI SPECIAL's original rear puller mechanism. These features make this series popular for attaching pre-closed elastic. KANSAI SPECIAL's unique automatic thread cutter (UTC) increases productivity by trimming threads accurately and leaving less thread, which curtail the production cost.

Multiaguja(4-21) cama cilíndrica alta velocidad doble cadenata. Con movimiento del garfio vertical, se puede usar para unir elástico y cinta, en ropa atlética, de dormir, expandidor de elástico, guía de aire para folder, y automático corta-hilos, también están disponibles en subclass y opciones. Kansai Special automático corta-hilos, aumenta la productividad, usando 2 cilindros de aire, cortando el hilo con exactitud, mientras mantiene el resto del hilo corto, circunferencia(420mm).

FX 系列是半筒式4针~21针，弯针纵向运动高速双重环缝纫机。各种服装的上松紧，滚条等。松紧张力器，气动开闭卷边器，自动切线等分型号，附属装置可供利用。独自设计的自动切线装置，确保切线和线残头很短。提高生产率。筒形外周长420mm，童装及上环状松紧变得很容易操作。

FXモデルシリーズ 表示方法

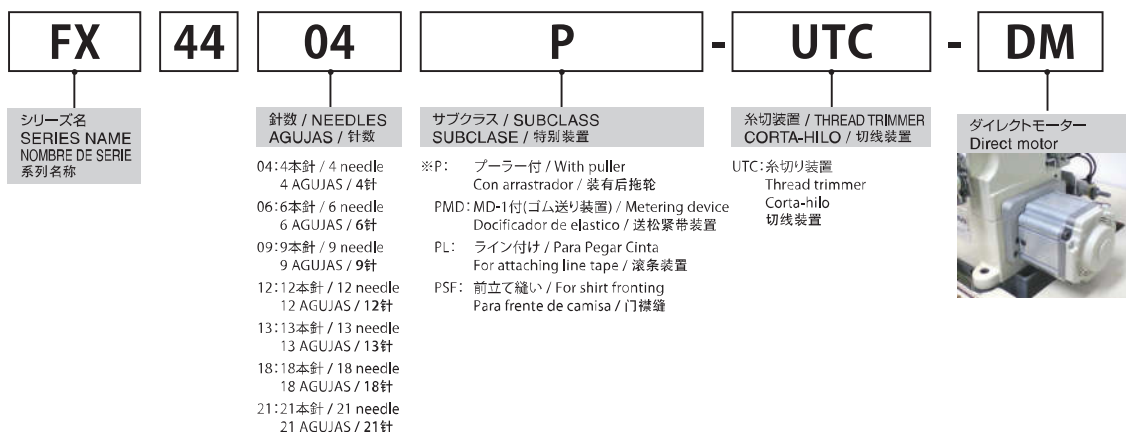

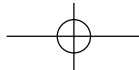
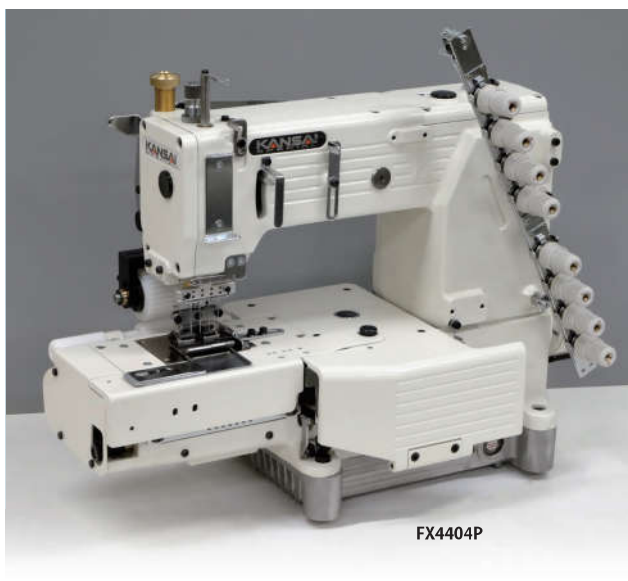
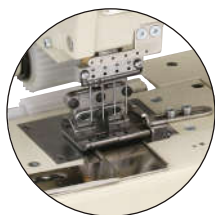
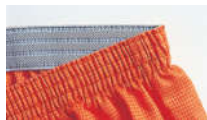
INDUSTRIAL SEWING MACHINES
PRODUCTS GUIDEFX4404P
FX4404PMD









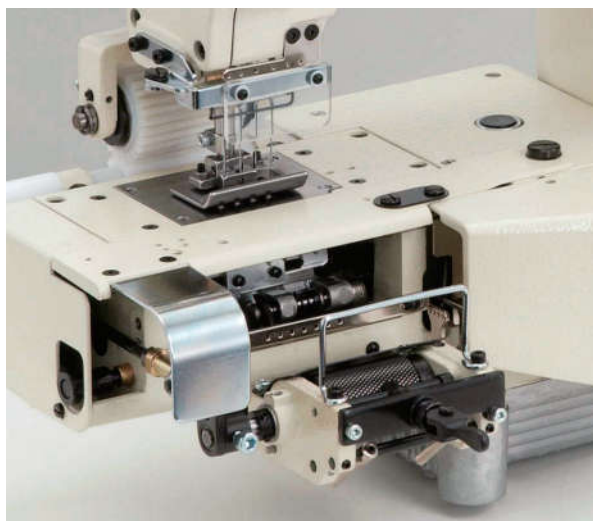







FX4404P

4本針二重環縫いシリンダーベッド、
丸ゴム付け用マシン4 needle, cylinder bed, double
chain stitch machine for attaching
pre-closed elastic.Cama cilíndrica de 4 agujas, para
pegar elástico en prendas pre-
cosidas.

4 针两重环缝筒式缝纫机

FX4404PMD (with metering device)



MODEL	No. of Needle 	No. of Thread 	Needle Type		Gauge (Inch) 	No. of Stitch (Stitch/Inch) 	Diff. Feed Ratio 	Presser Foot Lift (mm) 	Needle Bar Stroke (mm) 	Max. Speed (rpm) 
			Organ (#)	Schmetz (Nm)						
FX4404P	4	8	DV×57 14	DV×57 90	1, 3/4, 1-1/8, 1-1/4, 1-1/2	7~17		8	34.5	4500
FX4406P	6	12	DV×57 14	DV×57 90	1/4	7~17		8	34.5	4500
FX4408P	8	16	DV×57 14	DV×57 90	1/4	7~17		8	34.5	4500
FX4409P	9	18	DV×57 14	DV×57 90	1/4	7~17		8	34.5	4000
FX4412P	12	24	DV×57 14	DV×57 90	1/4, 5mm, 3/16	7~17		8	34.5	4000
FX4404PMD	4	8	DV×57 14	DV×57 90	1, 3/4, 1-1/8, 1-1/4, 1-1/2	7~17		8	34.5	4500
FX4406PMD	6	12	DV×57 14	DV×57 90	1/4	7~17		8	34.5	4500
FX4409PMD	9	18	DV×57 14	DV×57 90	1/4	7~17		8	34.5	4000
FX4412PMD	12	24	DV×57 14	DV×57 90	3/16, 1/4, 5mm	7~17		8	34.5	4000

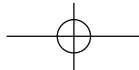

FX4406PL



6本針二重環縫いシリンダーベッド、ラインテープ付け用マシン

6 needle, cylinder bed, double chain stitch machine for attaching line tapes.

6 agujas para pegar líneas de cinta.

6针两重环缝筒式，滚条带用缝纫机

MODEL	No. of Needle	No. of Thread	Needle Type		Gauge (Inch)	No. of Stitch (Stitch/Inch)	Diff. Feed Ratio	Presser Foot Lift (mm)	Needle Bar Stroke (mm)	Max. Speed (rpm)
			Organ (#)	Schmetz (Nm)						
FX4406PL	6	12	DV×57 14	DV×57 90	1/4, 1/3	7~17		8	34.5	4500
FX4412PL	12	24	DV×57 14	DV×57 90	1/4	7~17		8	34.5	4000

FX4404PSF

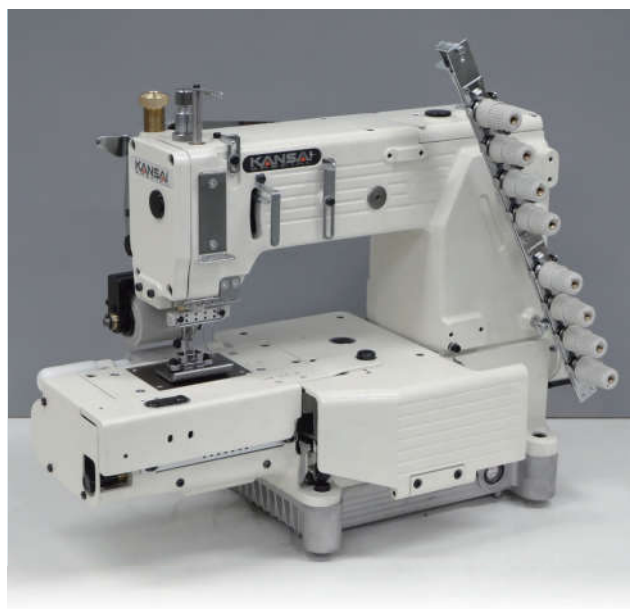

4本針シリンダーベッド、シャツの前立て用マシン

4 needle, cylinder bed machine with smooth puller for shirt fronting.

4 agujas, maquina de cama de cilindro con puller liso por camisa afrontar

4针两重环缝筒式，门襟用缝纫机
(由于有前导式松紧带拉料装置，适合缝衬衫的前身片)

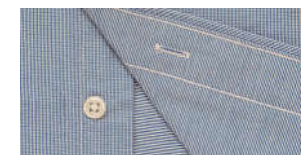

MODEL	No. of Needle	No. of Thread	Needle Type		Gauge (Inch)	No. of Stitch (Stitch/Inch)	Diff. Feed Ratio	Presser Foot Lift (mm)	Needle Bar Stroke (mm)	Max. Speed (rpm)
			Organ (#)	Schmetz (Nm)						
FX4404PSF	4	8	DV×57 14	DV×57 90	1/4-3/4-1/4 1/4-1-1/4	7~17		8	34.5	4500

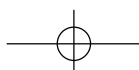

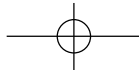
INDUSTRIAL SEWING MACHINES
PRODUCTS GUIDE

FX4404P-UTC

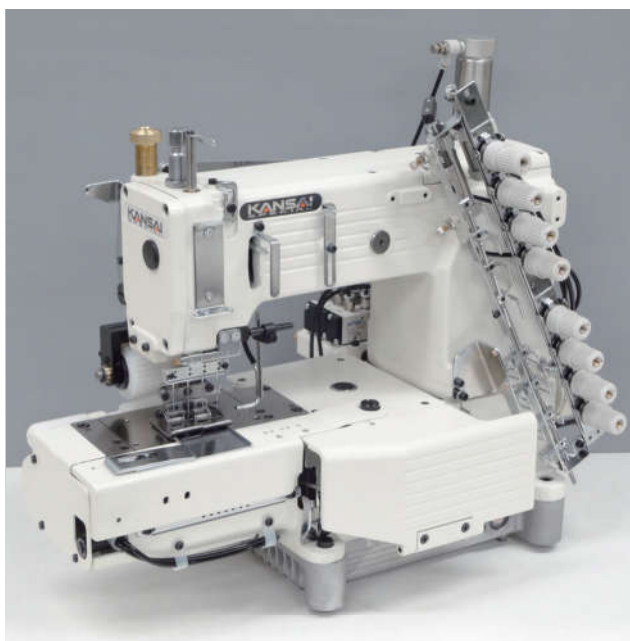
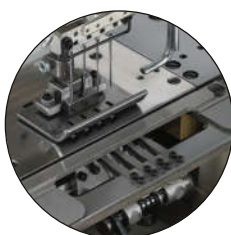
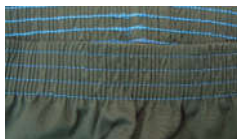

4本針二重環縫いシリンダー丸ゴム
付け用自動糸切り装置付マシン

4 needle, cylinder bed, double
chain stitch machine for
attaching pre-closed elastic, with
pneumatic thread trimmer.

Cama cilíndrica de 4 agujas,
para pegar elástico en
prendas precosidas, corta hilo
automáticamente

4 针双重环缝，筒式带自动剪线缝纫机



RT-1

FX4412P-UTC

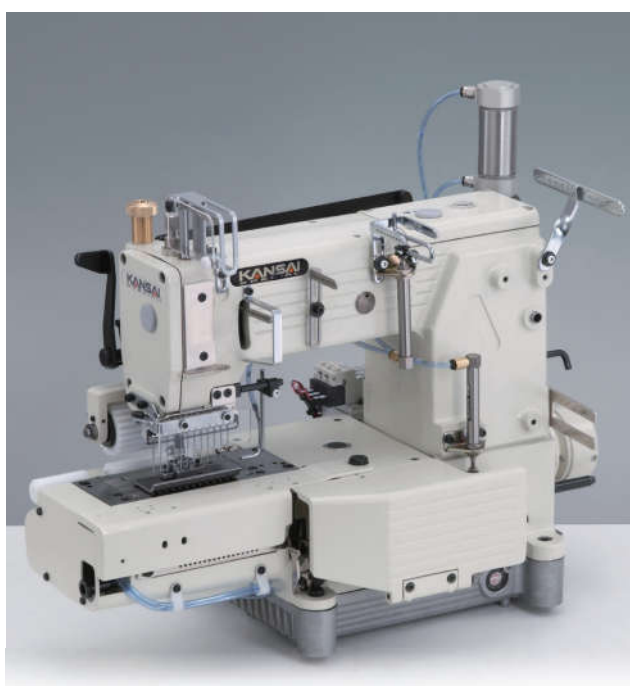
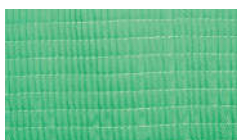
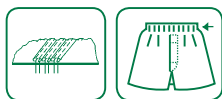

12本針二重環縫いシリンダー丸ゴム
付け用自動糸切り装置付マシン













12 needle, cylinder bed,
double chain stitch machine for
attaching pre-closed elastic with
pneumatic thread trimmer.

Cama cilíndrica de 12 agujas
para pegar elástico en
prendas precosidas, corta hilo
automáticamente.











12 针双重环缝，筒式带自动剪线缝纫机



RT-1

MODEL	No. of Needle 	No. of Thread 	Needle Type		Gauge (Inch) 	No. of Stitch (Stitch/Inch) 	Diff. Feed Ratio 	Presser Foot Lift (mm) 	Needle Bar Stroke (mm) 	Max. Speed (rpm) 
			Organ (#)	Schmetz (Nm)						
FX4404PUTC	4	8	DV×57 14	DV×57 90	1, 3/4, 1-1/8, 1-1/4, 1-1/2	7~17		8	34.5	4500
FX4406PUTC	6	12	DV×57 14	DV×57 90	1/4	7~17		8	34.5	4500
FX4409PUTC	9	18	DV×57 14	DV×57 90	1/4	7~17		8	34.5	4000
FX4412PUTC	12	24	DV×57 14	DV×57 90	1/4, 5mm, 3/16	7~17		8	34.5	4000



OTHER | TECHNICAL DATA 仕様明細

MODEL	No. of Needle 	No. of Thread 	Needle Type		Gauge (Inch) 	No. of Stitch (Stitch/Inch) 	Diff. Feed Ratio 	Presser Foot Lift (mm) 	Needle Bar Stroke (mm) 	Max. Speed (rpm) 
			Organ (#)	Schmetz (Nm)						
FX4411P	4	8	DV×57 14	DV×57 90	1/8-1/8-1/8-1/8 -1/4-1/4-1/8-1/8-1/8-1/8	7~17		8	34.5	4500
FX4413P	13	24	DV×57 14	DV×57 90	1/4-1/8-1/8-1-1 1/4-1/4-1/8-1-1 1/8-1/4-1/4- 1/8-1/8-1/4-	7~17		8	34.5	4000
FX4421P	21	24	DV×57 14	DV×57 90	1/8	7~17		8	34.5	4000
FX4423P	12	24	DV×57 14	DV×57 90	1/8	7~17		8	34.5	4000
FX4418P	6	12	DV x 57 14	DV x 57 90	1/8-1/8-1/8-1/8- 1/4-1/8-1/8-1/8- 1/4-1/8-1/8-1/8- 1/8-1/4-1/8-1/8- 1/8	7~17		8	34.5	4000

Gauge

■ F X ミシン特殊ゲージ表

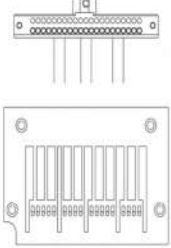
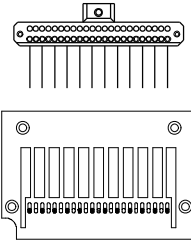
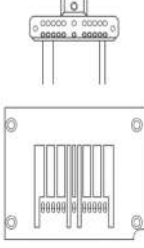
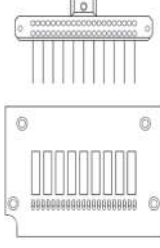
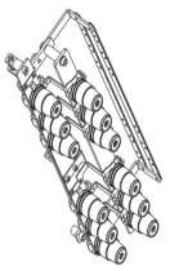
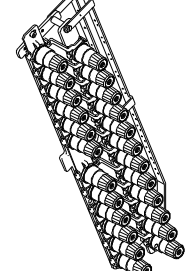
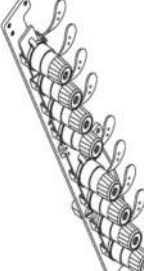
Special gauge description for Multi gauge machine
 Descripción de tamaño de aguja especial para Multi agujas
 Descrição de bitola especial para máquina Multi agulhas
 多针缝纫机特殊针距表

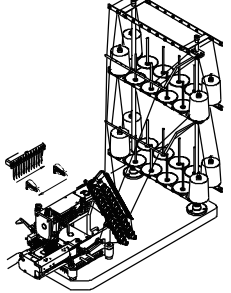
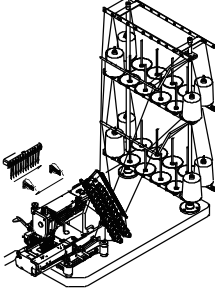
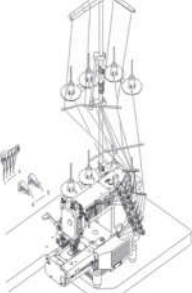
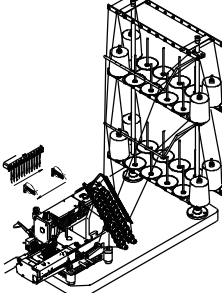
MODEL	FX4418P	FX4423P	FX4411P	FX4421P/PE ※
ゲージ Gauge Calibre 针位				
	1/8-1/8-1/8-1/8-1/4-1/8-1/8-1/8-1/4- -1/8-1/8-1/8-1/8-1/4-1/8-1/8-1/8"	1/4-1/8-1/8-1/4-1/4-1/4-1/8- 1/8-1/4-1/4-1/8-1/8"-1/4"	1/8-1/8-1/8-1/8-1/8-1/4- 1/4-1/8-1/8-1/8-1/8"	1/8"
糸調子セット Thread tension set Unidad de tensión de hilo				
	6X6	12X12	4X4	12X12
テーブルセット図外観 Overview Perspectiva 概要				
プーラー / Puller Arrastrador / 后拖轮	Gear	Gear	Gear	Gear/ Rubber

※ : Model -PE : Rubber Puller

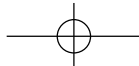

DX SERIES

DXシリーズは、シリンダーベッド(外径340mm)、2本から5本針、ルーパー横振り高速二重環縫いミシンです。トレーニングウェア、パジャマ、トラックス、スウェットパンツなどの丸物用ゴム付け専用モデルです。ゴム張り装置、エア一式開閉フォルダ、糸切り装置、左メス付きもサブモデル、オプションとしてご利用頂け、腰部ゴム付けの多様な縫製が可能です。

DX series is cylinder bed (circumference 340mm), from 2 to 5 needle double chain stitch machine with horizontal looper movement mechanism. It can be used for attaching endless or pre-closed elastic. Major feature of this series is the cylinder bed. This feature gives you benefits when you work with exercise wear, pajamas, trunks, boxers and similar garments.

Cama cilíndrica(340mm circunferencia), multi-agujas(2-5) doble cadeneta con movimiento horizontal del garfio. Excelente para unir elastico, incluyendo pre-cosido en ropa deportiva, de dormir, etc. Aparatos opcionales, expandidor de elastico, guia de aire para folder, corta hilos con aire, cuchillo izquierdo para cortar el borde de la tela, estas opciones hacen esta serie apropiada para unir elastico en la cintura.

DX 系列是半筒式 < 外周长 340cm > , 2 针到 5 针, 弯针横向运动的高速双重环缝纫机。用于各种环状松紧带上腰的专用机。松紧张力器, 气动开闭卷边器, 自动切线, 左切刀等附加装置可用于多种腰部上松紧。

DXシリーズ 表示方法

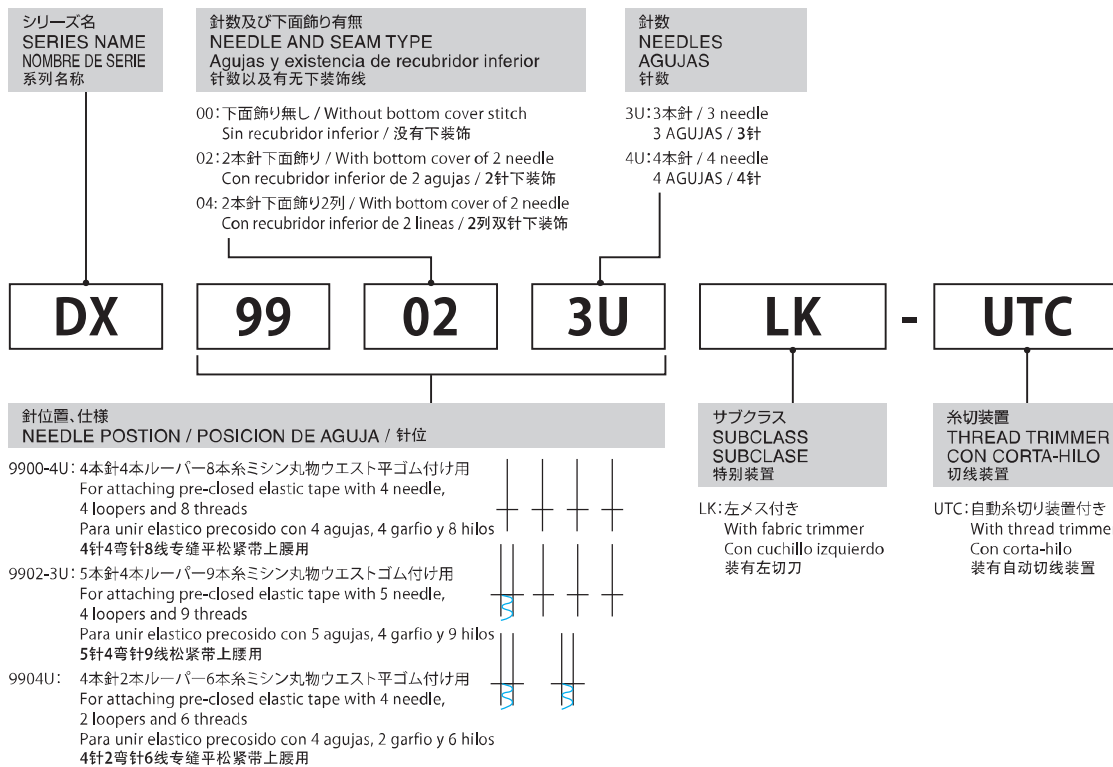

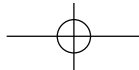

DX9900-4U



4本針二重環縫いシリンダーベッドゴム付用ミンシ

4 needle, cylinder bed, double chain stitch machine for attaching elastic.

Cama cilíndrica de 4 agujas para pegar elástico.

4 针半筒式 弯针横向运动, 上松紧带用缝纫机

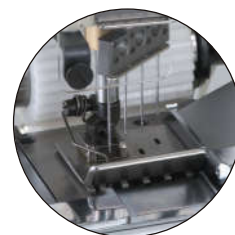

MODEL	No. of Needle	No. of Thread	Needle Type		Gauge (mm)	No. of Stitch (Stitch/Inch)	Diff. Feed Ratio	Presser Foot Lift (mm)	Needle Bar Stroke (mm)	Max. Speed (rpm)
			Organ (#)	Schmetz (Nm)						
DX9900-4U	4	8	TV×5 14	TV×5 90	6.4-6.4-6.4 8.5-8.5-8.5 9.5-9.5-9.5	7~16	8	33	4500	
DX9900-4U/UTC	4	8	TV×5 14	TV×5 90	6.4-6.4-6.4 8.5-8.5-8.5 9.5-9.5-9.5	7~16	8	33	4500	

DX9902-3U

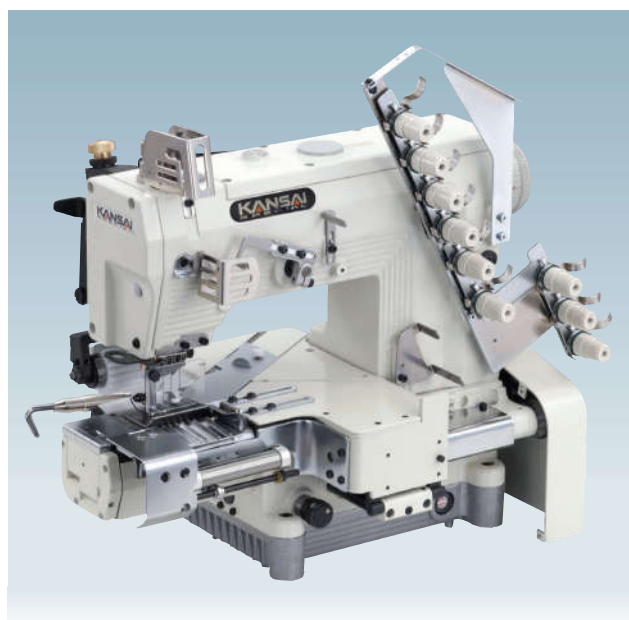

2本針下面飾り+3本針二重環縫いシリンダーベッドゴム付け用ミンシ

2 needle for bottom cover stitch, and 3 needle for double chain stitch, cylinder bed for attaching elastic.

2 agujas para recubridor inferior e 3 agujas para doble cadeneta, cama cilíndrica para pegar elástico.

筒式 2 针下面绷缝线迹, 和 3 针锁链底缝纫机

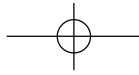

MODEL	No. of Needle	No. of Thread	Needle Type		Gauge (mm)	No. of Stitch (Stitch/Inch)	Diff. Feed Ratio	Presser Foot Lift (mm)	Needle Bar Stroke (mm)	Max. Speed (rpm)
			Organ (#)	Schmetz (Nm)						
DX9902-3ULK	5	9	TV×5 12	TV×5 80	4.8-10-10-10(mm) 5-13-13-13	7~16	8	33	4000	
DX9902-3ULK-UTC-A	5	9	TV×5 12	TV×5 80	4.8-10-10-10(mm) 5-13-13-13	7~16	8	33	4000	

INDUSTRIAL SEWING MACHINES
PRODUCTS GUIDE

DX9904U

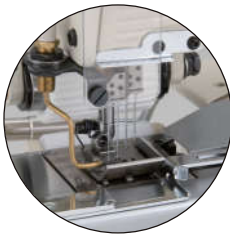
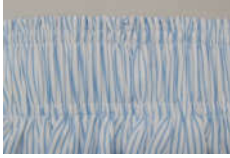

4本針シリンダーベッド二重環縫いゴム付け用マシン。
2列の偏平縫いができます。

4 needle, cylinder bed, double chain stitch machine for attaching elastic creating 2 lines of flat lock.

Cama cilíndrica de 4 agujas, 2 líneas de recubridor inferior para pegar elastico.

4 针 6 线 双 重 环 缝，上 腰 部 分 的 松 紧 带 缝 纫 机

■ 男性用下着のゴム付けに最適

Suitable for attaching elastic operation with double flatlock seams on men's underwear.

Adecuado para unir elastico con doble recubridor inferior en ropa interior de hombre.

适合用男性的内裤

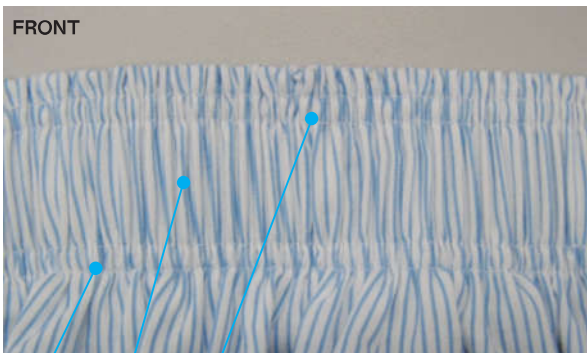

5mm 9mm 5mm
5mm 19mm 5mm

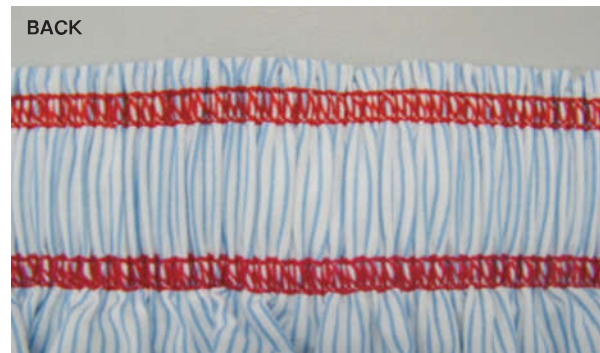
■ 2列の2本針の下面飾り縫いを一度で縫製できます。
また2列の間隔も均等に仕上げることができます。

2 lines of 2 needle bottom cover stitch seam in one operation with equal distance between the two cover stitch seams.

2 líneas de 2 agujas recubridor inferior a una operacion.

Tambien, la distancia entre puntada de recubridor es igual.

2 列 双 针 加 下 装 饰 缝，可 一 遍 完 成。

MODEL	No. of Needle	No. of Thread	Needle Type		Gauge (mm)	No. of Stitch (Stitch/Inch)	Diff. Feed Ratio	Presser Foot Lift (mm)	Needle Bar Stroke (mm)	Max. Speed (rpm)
			Organ (#)	Schmetz (Nm)						
DX9904U	4	6	TV×5 14	TV×5 90	5-9.5 5-19.5	7~16	—	8	33	4500
DX9904U/UTC	4	6	TV×5 14	TV×5 90	5-9.5 5-19.5	7~16	—	8	33	4500

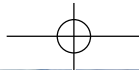

FBX SERIES

FBXシリーズは、ジーンズ、作業服など中厚から厚物まで幅広く縫える腰帯付け用シリンダーベッド型針送り二重環縫いミシンです。更にプラー機構をオプションで装備することができます。また、針送りと下送りが連動式ですので、プッシュボタンで送り目を変えるときも同時に送り量の変更ができます。従来の縫いズレやパッカリング、厚物縫製のスリップなども針送りにより問題なく縫うことが可能です。縦振りルーバー機構により糸も通しやすく、またシリンダーベッドですので、腰帯付け以外の丸物、ゴム入れ、前立てなど最大70mmまでの幅広い用途に使用できます。

FBX series is a cylinder bed, 2-6 needle double chain stitch machine with needle feed. It is designed for sewing waistbands of medium heavy to heavy material such as jeans and working pants. As needle feed and lower feed are linked, both feeding amounts can be adjusted at the same time by push button operation. An additional rear puller is available as option. The needle feed solves any problems, such as twisting, puckering and slipping of the material. FBX series has a wide range of applications as it can sew material up to a width of 70mm, especially tubular goods such as waistbands, elastic attaching, sewing shirts fronts and more.

FBX series cama cilíndrica con transportador de agujas 2-6 agujas, puntada de doble cadeneta para coser cinturas de material de mediano a pesado, como jeans, o pantalones de trabajo. El puler es opcional. El transportador de agujas y el alimentador inferior, están conectados, de esta manera la cantidad de alimentación, se puede ajustar al mismo tiempo, presionando el botón. El transportador de agujas resuelve problemas tales como torcida de material deslizamiento de material pesado, cuando se esta cosiendo, etc.

FBX 系列为筒式设计针送布从 2 ~ 6 针双链式的缝纫机，广泛应用于缝制从中厚料到厚重料的牛仔、工作服等的腰部或裤头，还可广泛应用于需上松紧带的地方，也可用于上门襟等等，针位宽度最大 70mm，加装各种装置用途更广。该系列机型因采用针送布机构和下送布机构的联动设计，所以通过按钮式调整缝迹长度可同步调整针和送布牙的送布量，这样就完全解决产品的变形、错位、打褶或鱼尾纹等等现象，达到产品平整的效果；该机型弯针为纵向摆动，穿线更简单容易；备有后拖轮装置可选购。

FBXシリーズ 表示方法

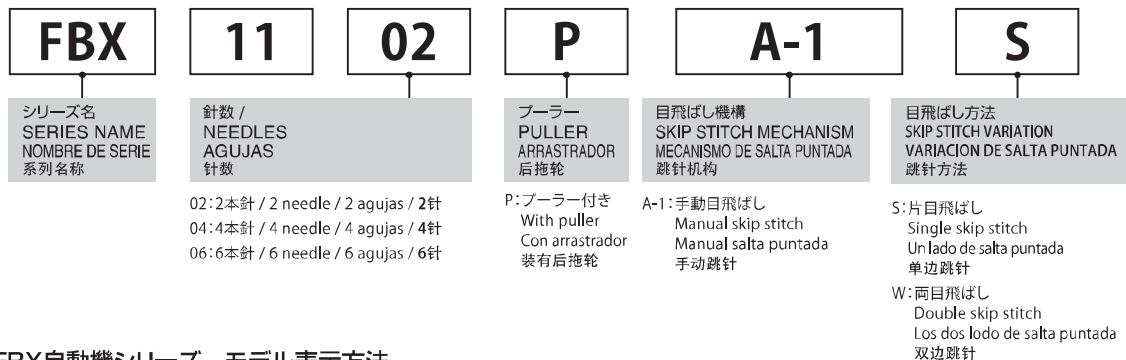

FBX自動機シリーズ モデル表示方法

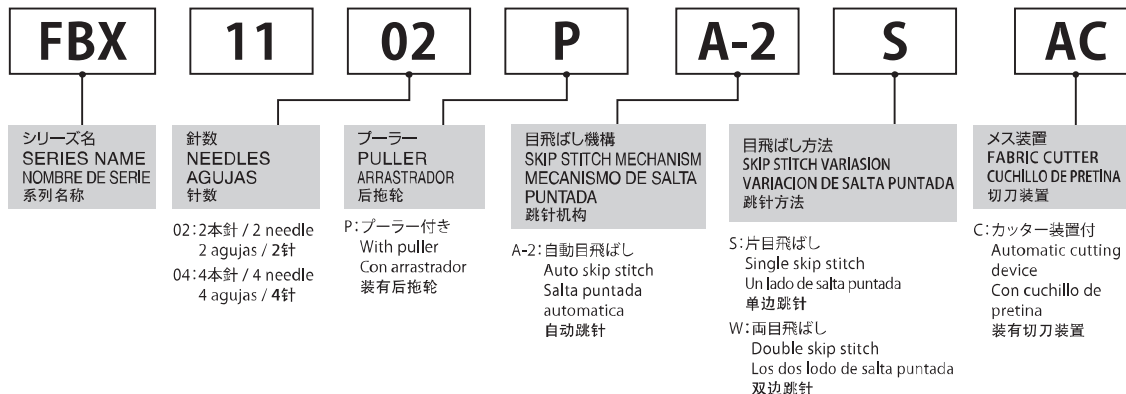

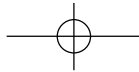
INDUSTRIAL SEWING MACHINES
PRODUCTS GUIDEFBX1104P
FBX1104PR

4本針 シリンダーベッド針送りマシン。
最大針幅38.2mm。

4 needle, cylinder bed needle
feed machine with wide range
of available gauge sizes. Needle
space up to 70mm.
Total needle width up to 38.2mm

Maquina de cama cilindrica 4
agujas doble cadeneta con
alimentador de agujas para varias
aplicaciones, con espacio de
38.2mm.

4 针针杆送布缝纫机

MODEL	No. of Needle	No. of Thread	Needle Type		Gauge (Inch)	No. of Stitch (Stitch/Inch)	Diff. Feed Ratio	Presser Foot Lift (mm)	Needle Bar Stroke (mm)	Max. Speed (rpm)
			Organ (#)	Schmetz (Nm)						
FBX1104P	4	8	DV X57 21 (#18~25)	DV X 57 130 (#110~200)	1/4-1-1/4, 1/4-7/8-1/4	4~12 (2.1~6.4mm)		9	32	4000

FBX1106P

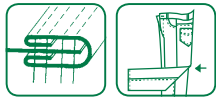

FBX1106P

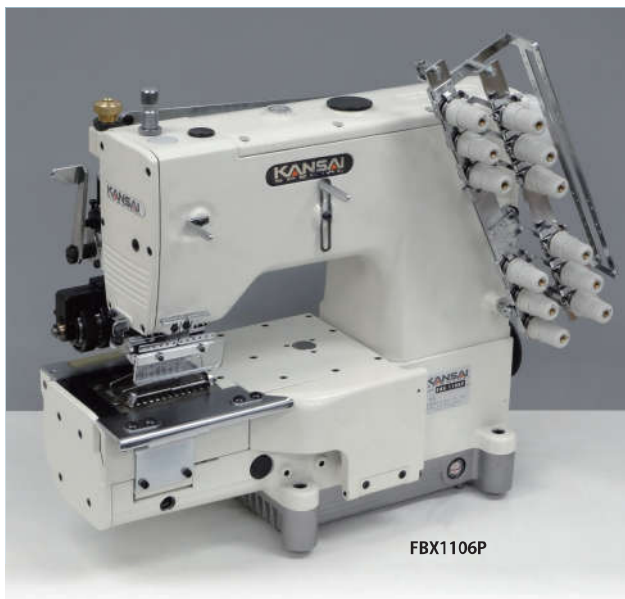

6本針 シリンダーベッド針送りマシン。
最大針幅70mm。

6 needle, cylinder bed needle
feed machine with wide range
of available gauge sizes. Needle
space up to 70mm.
Total needle width up to 70mm

Maquina de cama cilindrica 6
agujas doble cadeneta con
alimentador de agujas para varias
aplicaciones, con espacio de
70mm.

6 针针杆送布缝纫机

MODEL	No. of Needle	No. of Thread	Needle Type		Gauge (Inch)	No. of Stitch (Stitch/Inch)	Diff. Feed Ratio	Presser Foot Lift (mm)	Needle Bar Stroke (mm)	Max. Speed (rpm)
			Organ (#)	Schmetz (Nm)						
FBX-1106P	12 ※(6)	12	DV X57 21 (#14~25)	DV X 57 130 (#90~200)	1/4"	4~12		9	32	3000

※ 12本針の中70m/m(針間隔 1/4")の内6本針が使用可能です。

Max. 6 needle application is possible to use within the total gauge width at 70mm of 12 needle.

※ Es posible utilizar maximo 6 agujas en la capacidad de 70 mm de 12 agujas (1/4" entre agujas).

12 针的总针距是 70m/m, 针间距是 1/4, 也可以作为 6 针使用

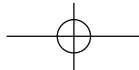

FBX1102PA-1S



FRONT BACK



2~4本針 シリンダーベッド針送りマシン。
目飛ばし機構付き。

2 to 4 needle machine with manual skip stitch device.

Maquina de cama cilindrica 2~4 agujas doble cadeneta con alimentador de agujas para brincar puntada.

2 ~ 4 针针杆送布

MODEL	No. of Needle	No. of Thread	Needle Type		Gauge (Inch)	No. of Stitch (Stitch/Inch)	Diff. Feed Ratio	Presser Foot Lift (mm)	NeedleBar Stroke (mm)	Max. Speed (rpm)
			Organ (#)	Schmetz (Nm)						
FBX1102PA-1S	2	4	DV X57 21 (#14~25)	DV X 57 130 (#90~200)	1-1/2, 1-3/8, 1-1/4	4~12		9	32	4000
FBX1104PA-1S	4	8	DV X57 21 (#14~25)	DV X 57 130 (#90~200)	1/4-1-1/4, 1/4-7/8-1/4	4~12		9	32	4000

FBX1104PA-2WAC

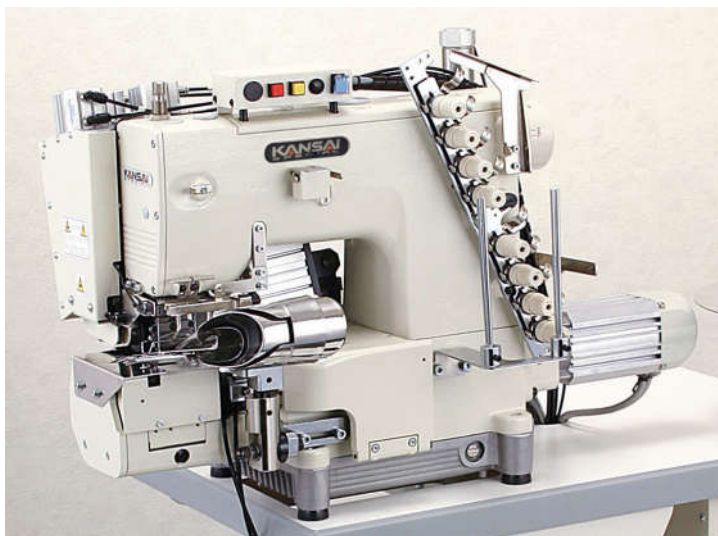

2(4)本針、針送り機構付きシリンダーベッド型腰帯付け用マシン。ダブルプラー装置、自動目飛ばし装置、自動カッターを装備した自動機です。

2 (4) needle, cylinder bed, with needle feed mechanism for attaching waistbands. Double puller, skip stitch device and automatic cutting device result in a uniform quality finish.

FBX PA-2WAC e uma maquina cilindrica,2(4)agujas e ponto duplo com alimentacao da agulha para unir o cos ao jeans.

Extrator duplo,mecanismo de ponto falho e cortador automatico que resultam uma qualidade final uniforme.A cadencia do moror sincroniza as pecas da alimentacao,automaticamente o cos (e sem cadeia) pode cortar e falhar os pontos que sao feitos durante a costura do comeco e no fim de acordo com a medida requerida.Todas as funcoes sao controladas eletricamente e facilmente programadas atraves do painel

2(4)针针杆送布牛仔上腰二重环缝纫机，带上下拖轮直驱式马达装置，裤腰成型后在任意自定尺寸处理，自动操作切割装置裤腰的腰头部可以任意跳线设定装置（起到缩段工时，不用再次折线作用）所有功能通过电子操作箱，操作起来特别方便

PA-2WAC
裤腰成型后在任意自定尺寸处理

MODEL	No. of Needle	No. of Thread	Needle Type		Gauge (Inch)	No. of Stitch (Stitch/Inch)	Diff. Feed Ratio	Presser Foot Lift (mm)	NeedleBar Stroke (mm)	Max. Speed (rpm)
			Organ (#)	Schmetz (Nm)						
FBX1102PA-2WAC	2	4	DV X57 21 (#14~25)	DV X 57 130 (#90~200)	1-1/4, 1-3/8	4~12		9	32	4000
FBX1104PA-2WAC	4	8	DV X57 21 (#14~25)	DV X 57 130 (#90~200)	1/4-1-1/4, 1/4-7/8-1/4	4~12		9	32	4000

FBX1102PA-2WAC-LS (Lock stitch & Chain stitch)

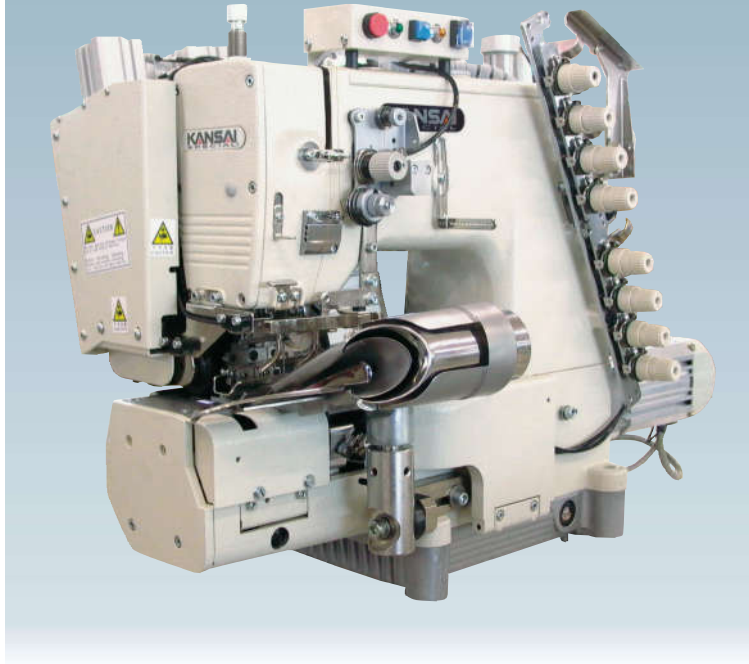

2本針、針送りシリンダーベッド本縫い+二重環縫い自動腰帯付けマシン。外側の針で本縫い、内側の針で二重環縫いを行います。また生地カットおよび目飛ばしを任意のタイミングで自動的に行います。

2 needle, cylinder bed, with needle feed mechanism, lock stitch & double chain stitch automatic machine for waistbands. The outside needle is for lock stitch, the inside needle for double chain stitch. Automatic cutting at the beginning and the end of sewing & automatic skip stitching device proceed automatically.

Maquina cilindrica automatica para cinturas, con alimentador de agujas, de dos agujas para jeans o similares. Este unidad automatica es una clase especial de nuestra FBX1102PA-2AC, mientras las agujas exteriores hacen costura recta, con un gancho rotativo y una bobina grande, las agujas interiores hacen costura de cadeneta. Este sistema de combinacion de costura recta y de cadeneta, elimina problemas tales como arrugar el material, dando un terminado nitido. Cuando se cose continuamente cintura, esta unidad auto-matica corta los dos extremos, tiene funcion automatica para salto de puntada, de tal forma que los dos extremos quedan sin coser.

2 针，针送筒式设计，牛仔裤等，自动缝裤腰专用机 FBX-1102PA-AC/LS 是这系列中的特等机，外侧针使用了大的筒管的正式缝制，内侧针是双重环缝正式缝制和双重环缝的组合实现了漂亮完成产品应为有后拉系统和送针系统提高了生产率

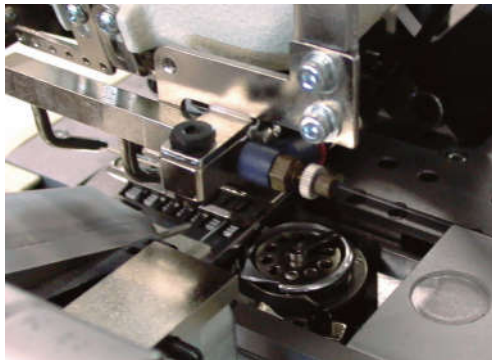

← 本縫
lock stitch / Puntada recta / 平缝线迹

← 二重環縫
chain stitch / Puntada de cadeneta / 链式线迹

MODEL	No. of Needle	No. of Thread	Needle Type		Gauge (Inch)	No. of Stitch (Stitch/Inch)	Diff. Feed Ratio	Presser Foot Lift (mm)	Needle Bar Stroke (mm)	Max. Speed (rpm)
			Organ (#)	Schmetz (Nm)						
FBX1102PA-2WAC-LS	2	4			1-1/2, 1-3/8, 1-1/4	4~12 (2.1~6.4m/m)		9	34	3000

NW・WX・NL SERIES

NW-WXシリーズは、フラットベッド、高速・高性能両面飾り偏平縫いミシンです。

1本針のNLから4本針のモデル(NW8804GD)まで、偏平縫いからテープ付け、かぶせ縫い、レースゴム付け、テープ取り、ポケット向布付け、シェルステッチテープ付けなど応用範囲の広いシリーズです。プッシュボタン式送り調節機構により、容易に縫い目の長さを調節することができます(最大4mm、6針/インチ)。安定した縫い調子、伸びのある美しい縫い目からあらゆるニット、メリヤス製品に最適です。

NW-WX series is flatbed, high speed, high performance with top and bottom cover stitch that have from 1 needle (NL) to 4 needle (NW8804GD), to be applied for any type of fabric and operation like plain stitch, covering, attaching elastic lace, taping, attaching pocket facing, shell stitching plus tape binding, and so on. Stitch length can be adjusted by push button easily (max. 4mm, 6 stitch/ inch). This series is most suitable for knit fabrics in order to achieve uniform, flexible and beautiful stitch formation.

NW-WX series maquina de carna plana, alta velocidad con recubridor arriba y abajo, desde una aguja, modelo NL hasta cuatro agujas, modelo WX8842-1 es posible usarlo en cualquier clase de telas y operaciones, tales como puntada regular, recubrir-pegar cinta elastica, forros de bolcillo, puntada de concha y otras mas. El largo de puntada se regula facilmente aplicando precion al boton regulador(max.:4mm, 6 puntadas por pulgada). Esta serie produce una puntada bonita y uniforme en telas de punto.

NW-WX 系列是平台式、高速、高性能两面绗缝的缝纫机。功能有一般装饰缝、滚领、花边松紧、滚条、裤袋的内衬布缝等广范围的系列缝纫机。通过按钮式调节, 简易改变缝纫线迹长度<最大 4mm, 6 针 / 1 英寸> 安定的缝纫, 美观的可伸缩的缝迹为针织最合适。

NW, WX/UFシリーズ 表示方法

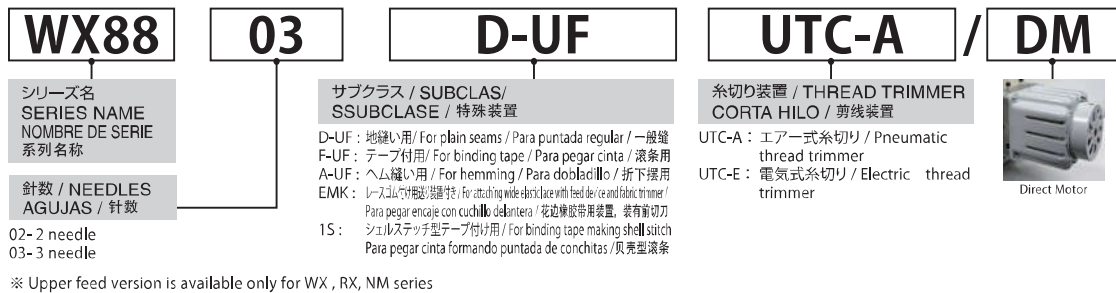
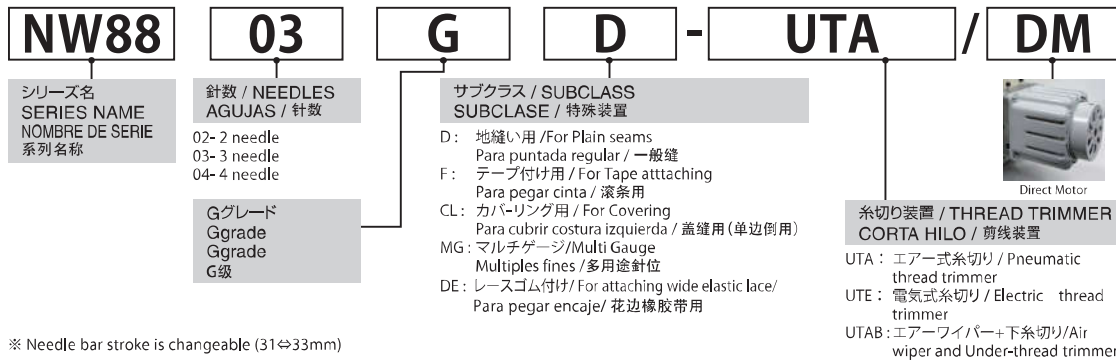

NLシリーズ 表示方法

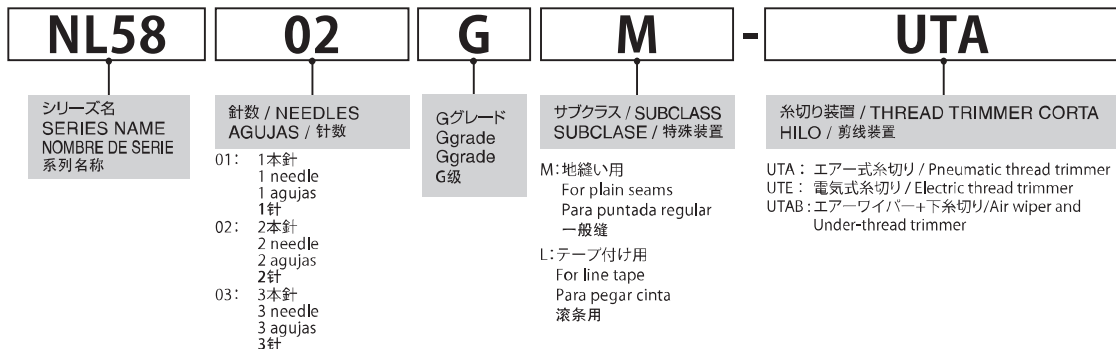

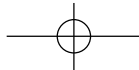

INDUSTRIAL SEWING MACHINES PRODUCTS GUIDE

TOP & BOTTOM

NW・WX・NL SERIES

KC SERIES

NR・NR・RX・UF SERIES

NC・NM・UF SERIES

NFS SERIES

NW8803GD

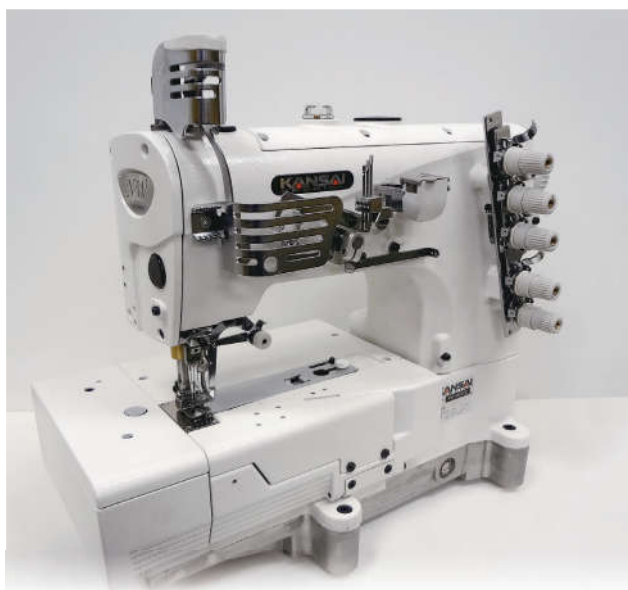

3本針両面飾り地縫いミシン

3 needle, flatbed, high speed, top and bottom cover stitch machine for plain seams

3 agujas doble cadeneta con recubridor superior y inferior para puntada regular

3 针两面装饰，平台式绷缝机

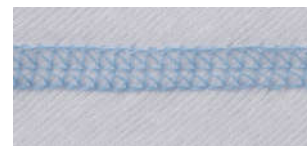

MODEL	No. of Needle	No. of Thread	Needle Type		Gauge (Inch)	No. of Stitch (Stitch/Inch)	Diff. Feed Ratio	Presser Foot Lift (mm)	Needle Bar Stroke (mm)	Max. Speed (rpm)
			Organ (#)	Schmetz (Nm)						
NW8803GD	3	5	UYX128GAS 9~14	UYX128GAS 60~90	7/32, 1/4	8~16 (1.6~3.2mm)	0.7~2	6	31 (31⇄33)	6000
NW8803GD-UTA NW8803GD-UTE										

NW8803GF

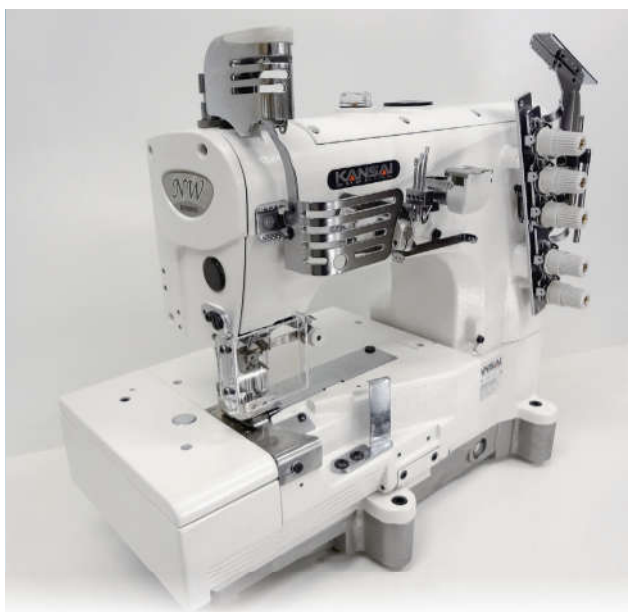
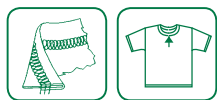

3本針両面飾りテープ付け用ミシン

3 needle, flatbed, high speed, top and bottom cover stitch machine for tape binding

3 agujas, para pegar cintas

3 针两面装饰平台式滚领绷缝机



MODEL	No. of Needle	No. of Thread	Needle Type		Gauge (Inch)	No. of Stitch (Stitch/Inch)	Diff. Feed Ratio	Presser Foot Lift (mm)	Needle Bar Stroke (mm)	Max. Speed (rpm)
			Organ (#)	Schmetz (Nm)						
NW8803GF	3	5	UYX128GAS 9~14	UYX128GAS 60~90	7/32, 1/4	8~16 (1.6~3.2mm)	0.7~2	6	31 (31⇄33)	6000

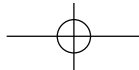

NW8803GMG

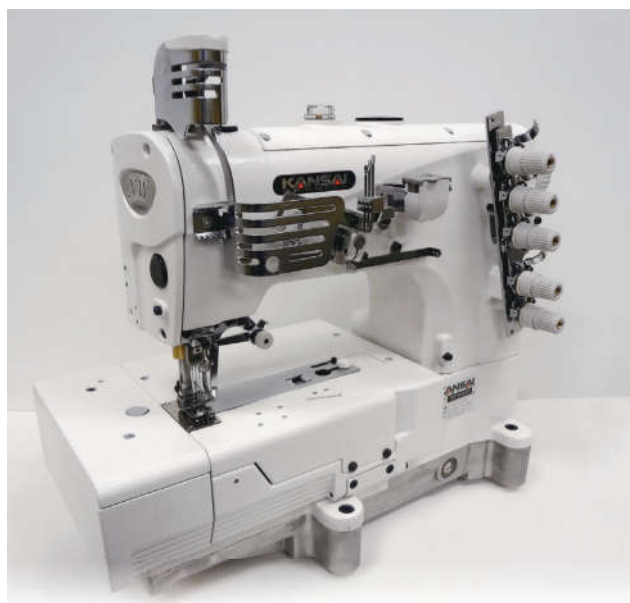

3本針両面飾りミシン
マルチゲージ（地縫い、ヘム縫い、テープ取り）

3 needles, flatbed, top and bottom cover stitch machine
multi gauge (plain seam, hemming, tape binding)

3 agujas, doble cadeneta con recubridor superior y inferior para de múltiples fines

平台式 3 針 5 线綳縫机
多用途针位（基本縫，下摆，拉滚领）

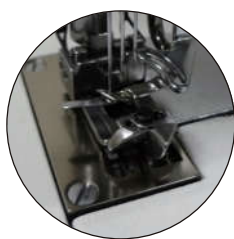

標準装備 / STANDARD EQUIPMENT / Equipo normal / 标准配件

テープ取り用（Fタイプ） / For tape binding (F type) / Para pegar collarete (Tipo F) / 拉滚领用（F型）



裾縫い用（Aタイプ） / For Hemming (A type) / Para dobladillo (Tipo A) / 下摆用（A型）



For tape attaching

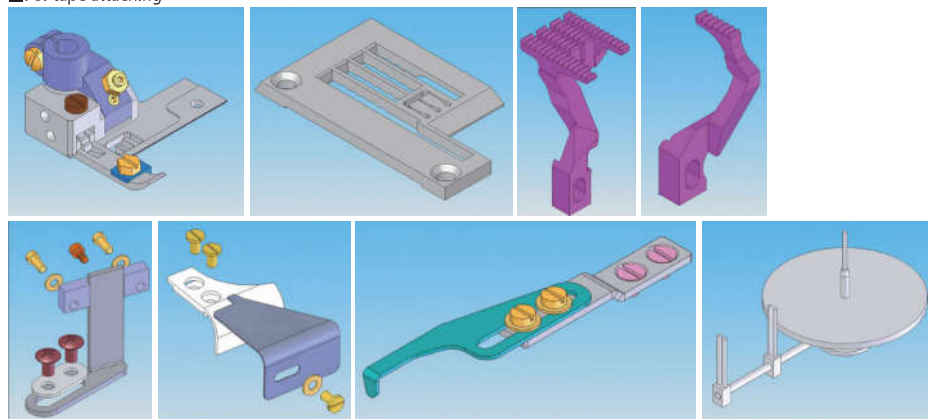

For hemming

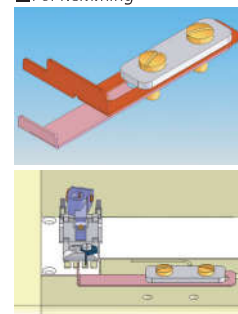

MODEL	No. of Needle	No. of Thread	Needle Type		Gauge (Inch)	No. of Stitch (Stitch/Inch)	Diff. Feed Ratio	Presser Foot Lift (mm)	Needle Bar Stroke (mm)	Max. Speed (rpm)
			Organ (#)	Schmetz (Nm)						
NW8803GMG	3	5	UYX128GAS 9~14	UYX128GAS 60~90	7/32, 1/4	8~16 (1.6~3.2mm)	0.7~2	6	31 (31↔33)	6000

※ Needle bar stroke is changeable (31↔33mm)

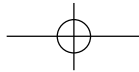

INDUSTRIAL SEWING MACHINES PRODUCTS GUIDE

TOP & BOTTOM

NW・WX・NL SERIES

KC SERIES

NR・NR・RX-UF SERIES

NC・NM-UF SERIES

NFS SERIES

NW8803GCL



3本針両面飾り片倒しカバーリング用ミシン

3 needle, flatbed, high speed, top and bottom cover stitch machine for covering left fold of overlock seams

3 agujas, cama plana, recubridor superior e inferior para cubrir costura de over lock

3 针两面装饰线迹包边缝缝机 (单面倒盖缝)

C TYPE



FRONT

BACK

CL TYPE

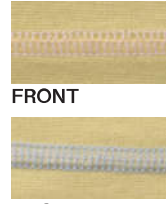

FRONT

BACK

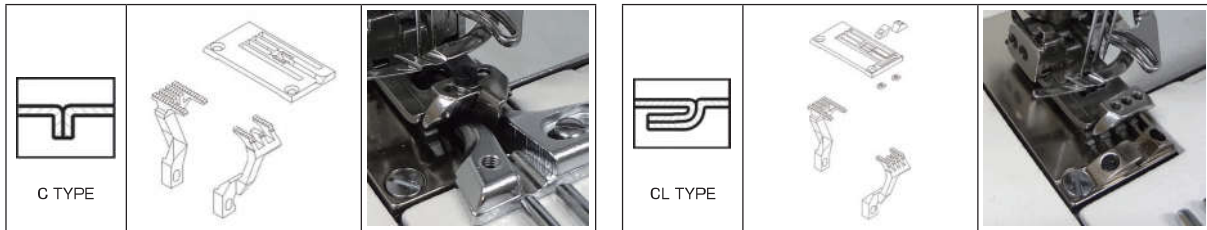

MODEL	No. of Needle	No. of Thread	Needle Type		Gauge (Inch)	No. of Stitch (Stitch/Inch)	Diff. Feed Ratio	Presser Foot Lift (mm)	Needle Bar Stroke (mm)	Max. Speed (rpm)
			Organ (#)	Schmetz (Nm)						
NW8802GCL NW8802GCL-UTA NW8802GCL-UTE	2	4	UYX128GAS 9~14	UYX128GAS 60~90	3/16	8~16 (1.6~3.2mm)	0.7~2	6	31 (31⇄33)	6000
NW8803GCL NW8803GCL-UTA NW8803GCL-UTE	3	5			7/32, 1/4					

WX8803F-UF



3本針両面飾り上下差動送り付テープ付け用ミシン

3 needle, flatbed, high speed, top and bottom cover stitch machine for tape binding with upper feed mechanism

3 agujas con alimentador superior para pegar cinta

3 针两面装饰平台式上下同步滚领缝缝机

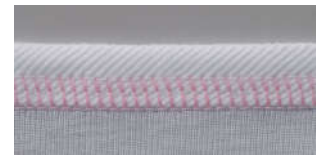

MODEL	No. of Needle	No. of Thread	Needle Type		Gauge (Inch)	No. of Stitch (Stitch/Inch)	Diff. Feed Ratio	Upper Feed Amount (mm)		Presser Foot Lift (mm)	Needle Bar Stroke (mm)	Max. Speed (rpm)
			Organ (#)	Schmetz (Nm)				←→	↑↓			
WX8802F-UF	2	4	UYX128GAS 9~14	UYX128GAS 60~90	1/8, 3/16	8~16 (1.6~3.2mm)	0.7~2	1~7	3.5~6	6	33	5500
WX8803F-UF	3	5			7/32, 1/4, 3/16							

NW8803GD-WD

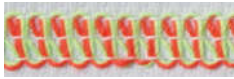

● オール&オール2重飾り
All & all -Dual stitch
Todo y todo-doble recubridor superior
全部双重装饰缝或者全部混合
双重装饰缝

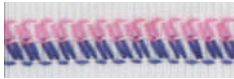

● ハーフ&ハーフ2重飾り
Half & half -Dual stitch
Mitad y mitad-doble recubridor superior
全部双重装饰缝或者半边混合
装饰缝



● オール&ハーフ2重飾り
All & half -Dual stitch
Todo y mitad-doble
recubridor superior
半边双重装饰缝或者混合半边
装饰缝



3本針上面ダブル飾り下面飾り縫い地縫い
ミシン

3 needle, flatbed, high speed dual
top and bottom cover stitch machine for
plain seam

3 agujas, cama plana, alta
velocidad, doble recubridor
superior y recubridor inferior para
puntada regular.

3 针上面双重装饰缝下面绷缝缝纫机

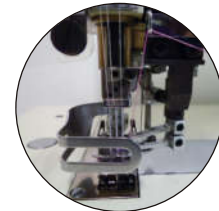

MODEL	No. of Needle	No. of Thread	Needle Type		Gauge (Inch)	No. of Stitch (Stitch/Inch)	Diff. Feed Ratio	Presser Foot Lift (mm)	Needle Bar Stroke (mm)	Max. Speed (rpm)
			Organ (#)	Schmetz (Nm)						
NW8803GD-WD	3	5	UY × 128GAS 10~14(標準11)	UY × 128GAS 65~90(標準75)	7/32", 1/4"	10~16	0.7~2	4.5	31	5000

WX8803EMK



3本針両面飾り前メス付ゴム送り装置付
ミシン

3 needle, flatbed, top and bottom
cover stitch machine with a fabric
trimmer and elastic feeding
mechanism for attaching elastic lace

3 agujas, recubridor superior
e inferior con cuchillo al frente
y dosificador de elastico
superior, con mecanismo para
pegar encajes

3 针两面装饰迹迹绷缝机
(带前切刀, 上松紧带用装置)



FRONT



BACK

MODEL	No. of Needle	No. of Thread	Needle Type		Gauge (Inch)	No. of Stitch (Stitch/Inch)	Diff. Feed Ratio	Presser Foot Lift (mm)	Needle Bar Stroke (mm)	Max. Speed (rpm)
			Organ (#)	Schmetz (Nm)						
WX8802EMK	2	4	UYX128GAS 9~14	UYX128GAS 60~90	1/8, 3/16, 5/32	8~16 (1.6~3.2mm)	0.7~2	5	31	5000
WX8803EMK	3	5			7/32, 1/4					

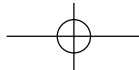
INDUSTRIAL SEWING MACHINES
PRODUCTS GUIDE

NW8842-1G



FRONT



BACK



NW8842-1G

ポケット向当布付用3本針上飾り縫い
ミシン安全縫い二重環付のため強度面で
優れています。

3 needle, flatbed, top cover stitch
machine with safety stitch for
attaching pocket facings
Double chain stitch produces
durable seams

3 agujas doble cadeneta con
recubridor superior, para pegar
forros de bolsillo

< NW8842-1G >

3 针上面装饰, 缝装兜用缝边机



NW8842-1G

MODEL	No. of Needle	No. of Thread	Needle Type		Gauge (mm)	No. of Stitch (Stitch/Inch)	Diff. Feed Ratio	Presser Foot Lift (mm)	Needle Bar Stroke (mm)	Max. Speed (rpm)
			Organ (#)	Schmetz (Nm)						
NW8842-1G	3	7	UYX128GAS 9~14	UYX128GAS 60~90	2.4×6.4	7~16 (1.6~3.6mm)	0.7~2	4.5	31	5000

WX8803-1S



FRONT 4:1



FRONT 5:1



FRONT 6:1



BACK



WX8803-1SMC30

4本針両面飾り縫いシェルステッチテー
プ取りミシン(2~4本までの下記表の
ゲージの種類があります。)また、新モデル
ではシェルの幅を3段階で調節できます

4 needle, flatbed, top and bottom cover
stitch machine for the shell (scallop)
stitching with tape binding
3 kinds of the shell (scallop) sizes
such as small, medium and big are
adjustable

3 y 1 agujas, recubridor superior e inferior, 1
aguja con doble, cadeneta, formando
puntada decorativa de conchitas

4 针两面装饰线迹, 贝壳缝胶带
(有 2 到 4 针的针位种类)
还可以贝壳缝的距离调整 3 段



MODEL	No. of Needle	No. of Thread	Needle Type		Gauge (mm)	No. of Stitch (Stitch/Inch)	Diff. Feed Ratio	Presser Foot Lift (mm)	Needle Bar Stroke (mm)	Max. Speed (rpm)
			Organ (#)	Schmetz (Nm)						
WX8802-1S	3	6	UYX128GAS 9~14	UYX128GAS 60~90	3.5×4	8~16 (1.6~3.2mm)	0.7~2	6	31	4500
WX8803-1S	4	7			5.6×4					

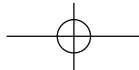

NW8804GD

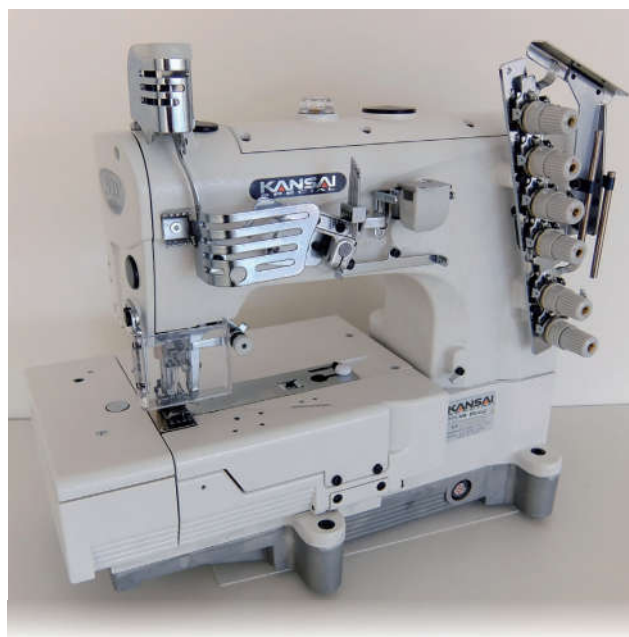

4本針両面飾り縫いミシン
ブリーフの股継ぎなどフラットシーマの
代わりとしてお使い頂けます。

4 needle, flatbed, top and bottom
cover stitch machine for joining
the crotch of briefs, instead of flat
seamer

4 agujas, cama plana, recubridor
superior e inferior para unir costuras

4 针两面装饰, 平台式绷缝机



FRONT



BACK

MODEL	No. of Needle	No. of Thread	Needle Type		Gauge (mm)	No. of Stitch (Stitch/Inch)	Diff. Feed Ratio	Presser Foot Lift (mm)	Needle Bar Stroke (mm)	Max. Speed (rpm)
			Organ (#)	Schmetz (Nm)						
NW8804GD	4	6	SM1014H 10S		6	8~16 (1.6~3.2mm)	0.7~2	6	31	4000
NW8804GD-UTA										

NL5802GLR



2本針二重環縫い、フラットベッド、ラップ
シーム用押え付きミシン

2 needle, flatbed, double chain
stitch machine for lap seam with
original presser foot

2 agujas, flatbed, la maquina de
puntada de cadena doble para
la costura del regazo con pie del
presser original

2 针两重环缝, 平台式埋夹缝缝纫机
(另外配备反向埋夹缝压脚。)

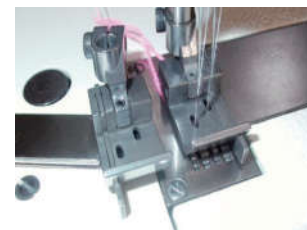

MODEL	No. of Needle	No. of Thread	Needle Type		Gauge (mm)	No. of Stitch (Stitch/Inch)	Diff. Feed Ratio	Presser Foot Lift (mm)	Needle Bar Stroke (mm)	Max. Speed (rpm)
			Organ (#)	Schmetz (Nm)						
NL5802GLR	2	4	UY128 GAS #16	UYX128 GAS 100	6.4	8~16 (1.6~3.2mm)		8	33	6000

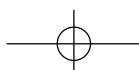

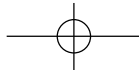

INDUSTRIAL SEWING MACHINES PRODUCTS GUIDE

TOP & BOTTOM

NW・WX・NL SERIES

KC SERIES

NR・NR・RX・UF SERIES

NC・NM・UF SERIES

NFS SERIES

NL5802GL



2本針二重環縫いテープ付ミシン

2 needle, flatbed, double chain stitch machine for attaching line tapes

2 agujas doble cadeneta; cama plana, para pegar cintas

2 针双重环缝，平台式滚领缝切机



MODEL	No. of Needle	No. of Thread	Needle Type		Gauge (Inch)	No. of Stitch (Stitch/Inch)	Diff. Feed Ratio	Presser Foot Lift (mm)	Needle Bar Stroke (mm)	Max. Speed (rpm)
			Organ (#)	Schmetz (Nm)						
NL5802GL	2	4	UYX128GAS 9~14	UYX128GAS 60~90	3/16, 1/4, 3/8	8~16 (1.6~3.2mm)	0.7~2	8	31	6000

NL5802GTMF



2本針二重環縫い、タンデム針ゲージ、マジック押え付ミシン
(特殊押えにより空環をきれいに出すことができます。)

2 needle (tandem needles), flatbed, double chain stitch machine with Magic Presser Foot (chain off can be made by the magic foot)

2 agujas (agujas tandem) doble cadeneta (agujas en linea), cama plana

2 针双重环缝，平台式缝切机 (0 针位)



FRONT



BACK

MODEL	No. of Needle	No. of Thread	Needle Type		Gauge (mm)	No. of Stitch (Stitch/Inch)	Diff. Feed Ratio	Presser Foot Lift (mm)	Needle Bar Stroke (mm)	Max. Speed (rpm)
			Organ (#)	Schmetz (Nm)						
NL5802GMF	2	4	UYX128GAS 9~14	UYX128GAS 60~90	2.4	8~16 (1.6~3.2mm)	0.7~2	8	31	6000
NL5802GTMF					0.4 (1/64 Inch)					

NL5803GPXP

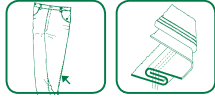

3本針フラットベッド二重環縫いラップシーム用マシン。

3 needle, flatbed, double chain stitch machine for lap seaming

3 agujas, cama plana, máquina de doble cadeneta para costura de cerrar

3 针双重环缝，平台式包边缝纫机



NL5803GPXP accessories



- Lap seam folder(6.4mm)
- Presser foot for closing the side stitch
- Standard Presser foot
- Smooth rubber puller

MODEL	No. of Needle	No. of Thread	Needle Type		Gauge (Inch)	No. of Stitch (Stitch/Inch)	Diff. Feed Ratio	Presser Foot Lift (mm)	Needle Bar Stroke (mm)	Max. Speed (rpm)
			Organ (#)	Schmetz (Nm)						
NL5803GPXP	3	6	TV×5 18		1/4	6~14		8	31	5000

WX OTHER MODELS TECHNICAL DATA 仕様明細

MODEL	No. of Needle	No. of Thread	Needle Type		Gauge (Inch)	No. of Stitch (Stitch/Inch)	Diff. Feed Ratio	Upper Feed Amount (mm)		Presser Foot Lift (mm)	Needle Bar Stroke (mm)	Max. Speed (rpm)
			Organ (#)	Schmetz (Nm)				↔	↕			
NW8803GDE	3	5	UY×128GAS 9~14	UY×128GAS 60~90	7/32, 1/4	8~16 (1.6~3.2mm)	0.7~2	1~7	3.5~6	6	33	5500
WX8803D-UF												
WX8803D-UF-UTC-A/E												
WX8802A-UF					3/16							
WX8803A-UF	2	4			7/32, 1/4							
WX8803AH-UF	3	5	UY×128GAS 18		1/4	6 (4.2mm)						

NL OTHER MODELS TECHNICAL DATA 仕様明細

NL5801G	1	2	UYX128GAS 9~14	UYX128GAS 60~90		8~16 (1.6~3.2mm)	0.7~2	8	31	6000
NL5801G-UTAB	1	2			1/4 (6.4mm)					
NL5802GM	2	4								
NL5803GPHD	3	6	TV×5 18		1/4, 3/8, 5/16	6~14				5000
NL5803GPTF										

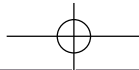

KC SERIES

KCシリーズは、縦筒シリンダーベッド、高性能両面飾り縫い偏平縫いミシンです。

3本針または4本針の両面飾り縫いミシンでTシャツの袖、裾のヘム縫いやオーバーロックの縫いのカバーリング、左倒しに最適です。また筒状のシリンダー形状により袖などの部分も縫製がし易く送りピッチもプッシュボタンにより簡単に変わることができます。(自動糸切り装置付はダイレクトモーター付き仕様になります。)

KC Series is vertical cylinder bed, high performance with top and bottom cover stitch.

This model is suitable for hemming and covering (including covering left fold of the overlock seams) of knit wear. The vertical cylinder can operate easily for long sleeve knit wear and also stitch length is adjusted by push button. (As a standard option, automatic thread trimmer is including with the direct drive motor)

La serie KC es de cama vertical cilíndrica, de alto rendimiento con puntada de recubrimiento superior e inferior.

Este modelo es adecuado para hacer el dobladillo y cubre (incluido la cobertura del pliegue izquierdo de las costuras overlock) de ropa de punto. El cilindro vertical se usa para un fácil funcionamiento en manga larga y también la longitud de puntada se ajusta mediante pulsador. (Como opción, el condensador de ajuste automático del hilo está disponible con motor de accionamiento directo)

KC 系列为竖筒式机壳的高性能绷缝机。

3 针或 4 针绷缝机适合于 T 恤衫的袖口和下摆，或者包缝上面的立骨和倒骨。

竖筒式机壳的形状非常适合于袖口等部分的缝制，并针码也经过按钮容易进行调整长短。(带自动剪线装置的机型为标配直驱马达)

KCシリーズ 表示方法

KC27

シリーズ名
SERIES NAME
NOMBRE DE SERIE
系列名称

03

針数 / NEEDLES
AGUJAS / 针数
03- 3needle
04- 4needle

UTC-A

用途 / APPLICATIONS /
APLICACIONES / 用途

Thread Trimmer

UTC-A: エア式上下糸切り / Pneumatic thread trimmer / Corta hilo neumático / 气动式上下切线
UTC-E: 電気式上下糸切り / Electric thread trimmer / Corta hilo eléctrico / 电动式上下切线

CL TYPE		
C TYPE		
A TYPE		

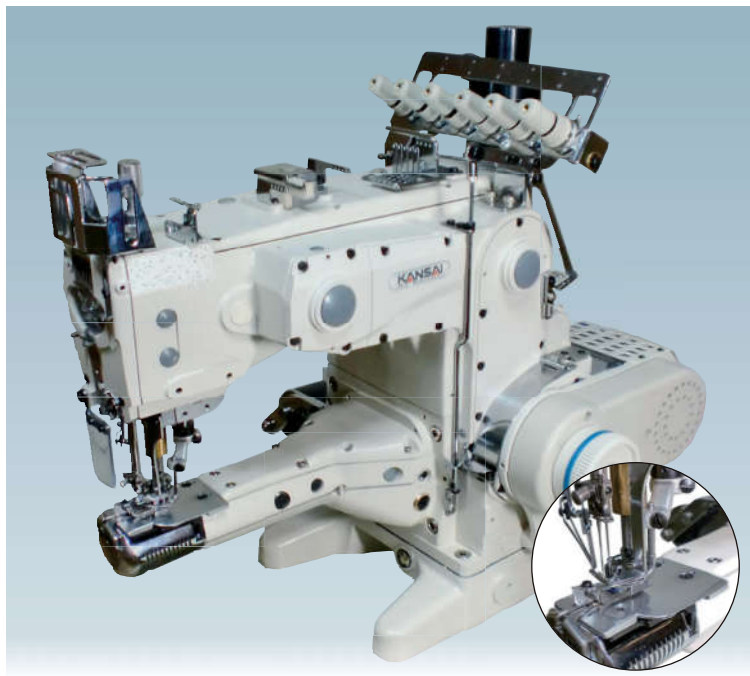

KC2703/UTC-E

3本針両面飾り縫い縦筒ミシン

3 needle, vertical cylinder bed, top and bottom cover stitch machine

3 agujas, cama vertical cilíndrica, con recubrimiento superior e inferior

竖筒式 3 针绷缝机



FRONT



BACK



外付けハマガリ機構により、糸通しや調整が簡単にできます。はまぐりへの糸の巻き付きも糸を取り除くことがより簡単にできます。The exterior take-up cam makes threading and adjustment easier. It is easier to get rid of thread winding.

El exterior de recogida de levas hace el enhebrado y un ajuste más fácil. Es más fácil para deshacer el hilo bobinado. 図採用打线拖轮外置式，可容易进行穿线和调整。在拖线轮的缝线也可容易拆除。

送り目変更がプッシュボタン式で簡単に調整可能です。Stitch length can be adjusted by the push button easily. La longitud de puntada se puede ajustar fácilmente mediante el botón de ajuste. 经过按钮可进行调整针码。



ダイレクトモーターにより安定的、そして両面ミシン操作が可能です。Direct drive motor makes sewing work stable and easy. El motor de accionamiento directo, hace el trabajo de costura más fácil y estable. 直驱马达能实现更稳定的缝制和简单的操作。

MODEL	No. of Needle	No. of Thread	Needle Type		Gauge (mm)	No. of Stitch (Stitch/Inch)	Diff. Feed Ratio	Presser Foot Lift (mm)	Needle Bar Stroke (mm)	Max. Speed (rpm)
			Organ (#)	Schmetz (Nm)						
KC2703/UTC-A, E	3	5	TVx7 9~14	TVx7 60~90	5.6, 6.4	6~21 (1,2~4,2mm)	0.8~2	8	31.5	4500
KC2704/UTC-A, E	4	6	TVx7 9~14 SM1014H #10S	TVx7 60~90 SM1014H #10S	6					

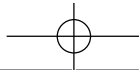

NR・NRE SERIES

NR・NREシリーズは、当社独自の設計によるセミシリンダー(外径280mm)、超高速・高性能両面飾り偏平縫いミシンです。

1本針(ジーンズ裾三ツ巻き用)から4本針(NR9804GD)まで、平縫い、かぶせ縫い、裾引き、ゴム付け、天ゴム付けなど、応用範囲の広いモデルです。また、用途によりプラー、右メス、左メスを装備したモデルもあります。(また、新モデルのNREは、下糸捌き機構をマシン外部に設置することにより、扱いやすさをさらに増しています。さらに5種類のゲージパーツを同梱した“MG”は、あらゆる用途に対応します。)

NR・NRE series is a high speed and high performance with top and bottom cover stitch machine of cylinder bed (circumference 280mm), which is uniquely designed by us. This series has wide range of models from 1 needle (for hemming of jeans) to 4 needle (NR9804GD), and for various kinds of operations like plain stitching, covering, hemming, attaching elastic, attaching pre-closed elastic to men's briefs, and so on. Also, available for models equipped with puller, right knife, left knife, and so on. Stitch length can be adjusted by a push button easily (max. 4mm, 6 stitches/inch). A maximum sewing speed is 6000rpm, so the productivity will be upgraded. The latest line of NRE that has just been introduced has the looper thread take-up cam outside of the machine for easier handling. The new subclass MG includes 5 different gauges in 1 machine for various purposes

NR・NRE series alta velocidad, con recubridor superior y inferior, cama cilíndrica circunferencia (280mm) diseñada por nosotros. Esta serie tiene varios modelos; de una aguja para ribete jeans y de 4 agujas (NR9804GD). Se puede aplicar en varios como puntada regular—para cubrir ribete, pegar elastico, adaptar elastico en prendas pre-cerradas, y otras funciones. Tambien modelos con puler y cuchillos de izquierda y derecha, longitud de puntada facilmente se ajusta por medio del boton (max. 4mm, 6 puntadas/pulgada). Velocidade maxima de coser 6000rpm. Y, nuevo modelo “NRE” realiza facil mantenimiento por “Mecanismo de levanta-hilo de garfio equipado fuera de maquina”. Y tambien, la subclase “MG” viene con 5 tipos de aplicaciones para multi-operacion.

NR・NRE 系列是我公司独特设计的半筒式<外周 280mm>超高速,高性能两面绷缝的缝纫机。1针<牛仔裤卷边缝>4针细缝,盖缝,卷边,松紧带缝等广范围的系列缝纫机。

另外,新款的NRE系列是根据打线器设定在外边,在它的附近发生的问题可容易解决。而且,装有5种的针位的MG系列可对应各种的用途

NR・NRE・RX/UFシリーズ 表示方法

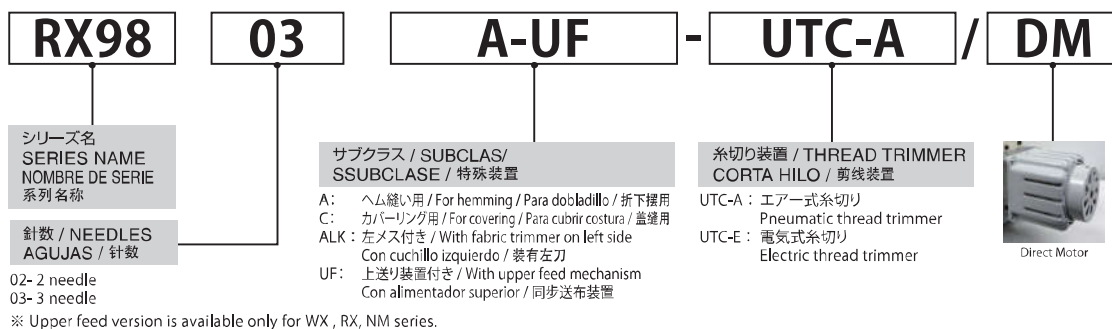
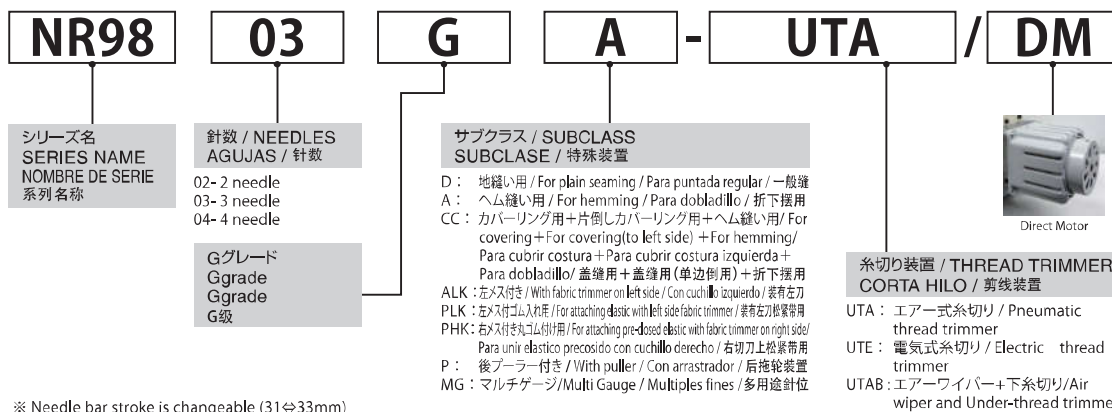

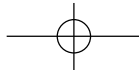

INDUSTRIAL SEWING MACHINES PRODUCTS GUIDE

TOP & BOTTOM

NW・WX・NL SERIES

KC SERIES

NR・NR・RX-UF SERIES

NC・NM-UF SERIES

NFS SERIES

NR9803GA



3本針両面飾りセミシリンダー型裾引き用マシン

3 needle, cylinder bed, top and bottom cover stitch machine for hemming

3 agujas, cama cilíndrica, recubridor superior e inferior para dobladillos

3 针两面装饰，筒式绷缝机



MODEL	No. of Needle	No. of Thread	Needle Type		Gauge (Inch)	No. of Stitch (Stitch/Inch)	Diff. Feed Ratio	Presser Foot Lift (mm)	Needle Bar Stroke (mm)	Max. Speed (rpm)
			Organ (#)	Schmetz (Nm)						
NR9803GA	3	5	UYX128GAS 9~14	UYX128GAS 60~90	7/32, 1/4	6~16 (1.6~4.2mm)	0.3~2.9	6	31 (31⇄33)	6000
NR9803GA-UTA										
NR9803GA-UTE										

NR9803GP



P - Gear puller
PE - Smooth puller

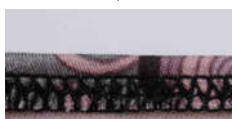

3本針両面飾りセミシリンダー、プーラー、ゴム入れ用マシン

3 needle, cylinder bed, top and bottom cover stitch machine with rear puller for attaching elastic

Cama cilíndrica 3 agujas recubridor superior e inferior. Para pegar elastico, con arrastrador

3 针两面装饰迹绷缝机带后拖轮，可上松紧带

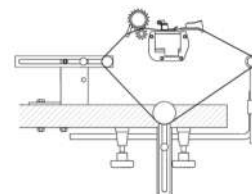

同梱品 / IN ACCESSORY BOX

MODEL	No. of Needle	No. of Thread	Needle Type		Gauge (Inch)	No. of Stitch (Stitch/Inch)	Diff. Feed Ratio	Presser Foot Lift (mm)	Needle Bar Stroke (mm)	Max. Speed (rpm)
			Organ (#)	Schmetz (Nm)						
NR9803GP	3	5	UYX128GAS 9~14	UYX128GAS 60~90	7/32, 1/4	6~16 (1.6~4.2mm)	0.3~2.9	6	33 (31⇄33)	4800
NR9803GP-UTA										
NR9803GP-UTE										

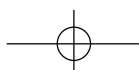

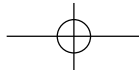

NR9803GCC



3本針両面飾りセミシリンダー型カバーリング用マシン

3 needle, cylinder bed, top and bottom cover stitch machine for left fold covering

Cama cilíndrica 3 agujas recubridor superior e inferior

3 针两面装饰线迹包边缝绗缝机





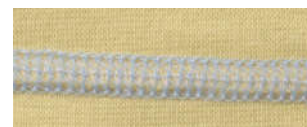



FRONT

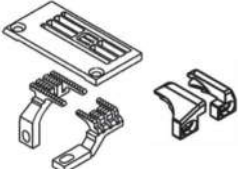

BACK

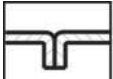
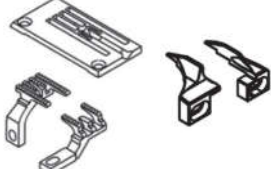
MODEL	No. of Needle	No. of Thread	Needle Type		Gauge (Inch)	No. of Stitch (Stitch/Inch)	Diff. Feed Ratio	Presser Foot Lift (mm)	Needle Bar Stroke (mm)	Max. Speed (rpm)
			Organ (#)	Schmetz (Nm)						
NR9803GCC	3	5	UYX128GAS 9~14	UYX128GAS 60~90	7/32, 1/4	6~16 (1.6~4.2mm)	0.3~2.9	6	31 (31↔33)	6000
NR9803GCC-UTA NR9803GCC-UTE										

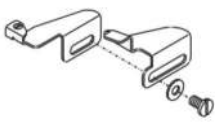
ゲージ比較 / GAUGE COMPARISON / comparación de las máquinas que cubre / 盖缝机的相比

 CL TYPE	 STANDARD	
 C TYPE	 IN ACCESSORY BOX	
 A TYPE	 IN ACCESSORY BOX	

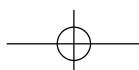

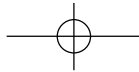

INDUSTRIAL SEWING MACHINES
PRODUCTS GUIDE

TOP & BOTTOM

NW・WX・NL SERIES

KC SERIES

NR・NR-E・RX-UF SERIES

NC・NM-UF SERIES

NFS SERIES

NR9803GPEHK-UTA

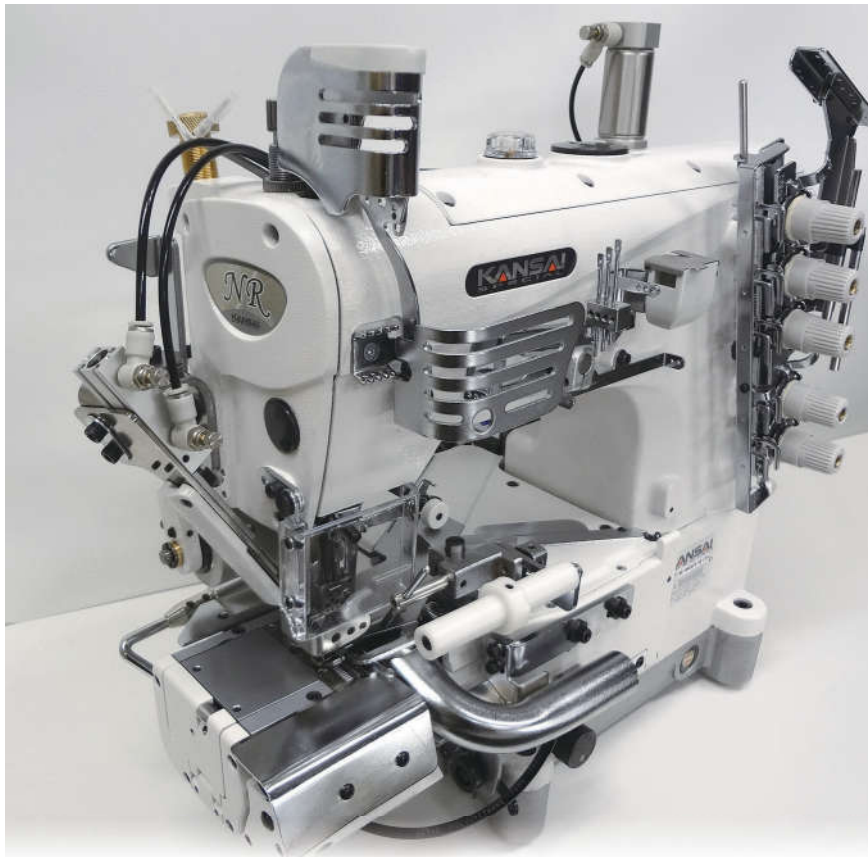

3本針下面飾りセミシリンダー
天ゴム付け用マシン

3 needle, cylinder bed machine
with fabric trimmer and smooth
puller for attaching pre-closed
elastic to men's underwears

3 agujas, máquina de cama de
cilindro con la recortadora de
tejido y el puller liso por atar el
preclosed elástico a las ropas
interior de hombres

3 针圆筒上松紧带缝纫机



・PEHK : Smooth Puller
・PGHK : Gear puller

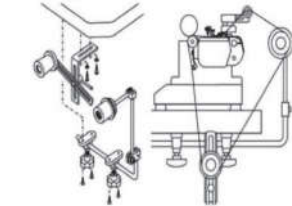

同梱品 / IN ACCESSORY BOX

■ NR-PHKのメスドロップ機構 / Drop knife system El sistema de caída de cuchillo / NR-PHK的刀组雨量装置

矢印のボタンとレバーにより、針板下面
で上メスの駆動を止めることができます。
メスを必要としない縫製の場合に、御使
用ください。

By pushing Button A & Lever B,
the height of the knife can be set
up under the surface of the needle
plate.

It is useful for the sewing operation
without fabric trimmer.

Empujando Botón UN & Palanca
B, la altura del cuchillo puede
prepararse bajo la superficie del
plato de la aguja.

Es útil para el funcionamiento de la
costura sin la recortadora de tejido.

使用箭头所指的按钮和连杆可以控制针板下面刀组的运动。
在缝制操作上不需要用刀片的时候，可以采用这项功能。

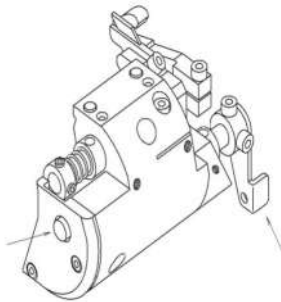

■ プーラーは仕様によりギヤーまたはゴムプーラーがお選びいただけます。 Please choose either "Gear puller (PG-HK)" or "Smooth puller (PE-HK) depending on your specification Se puede elegir "Puller de diente (PG-HK)" o "Puller de goma (PE-HK) dependiendo de su especificación

根据缝制的要求可选择使用齿轮拖轮和橡胶平拖轮。

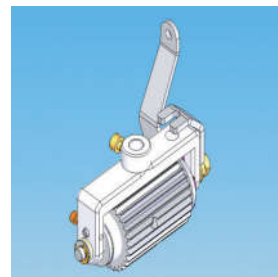

PGHK
(Gear puller)

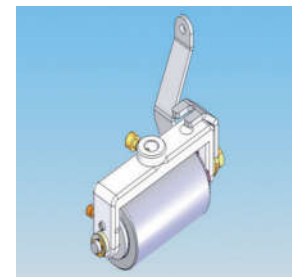

PEHK
(Smooth puller)

MODEL	No. of Needle	No. of Thread	Needle Type		Gauge (Inch)	No. of Stitch (Stitch/Inch)	Diff. Feed Ratio	Presser Foot Lift (mm)	Needle Bar Stroke (mm)	Max. Speed (rpm)
			Organ (#)	Schmetz (Nm)						
NR9803GPEHK	3	5	UYX128GAS 9~14	UYX128GAS 60~90	7/32, 1/4	6~16 (1.6~4.2mm)	0.3~2.9	5	33 (31↔33)	4800
NR9803GPGHK										
NR9803GPEHK-UTA										
NR9803GPGHK-UTA										

NR9803GALK-UTA

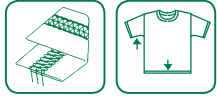

3本針両面飾りセミシリンダー
裾引き用左メス付きミシン

3 needle, cylinder bed, top and bottom cover stitch machine with a fabric trimmer built in to the left of the needles for hemming

3 agujas, cama cilíndrica, recubridor superior e inferior con cuchillo izquierdo para dobladillo

3 针两面装饰缝线机带左切布刀

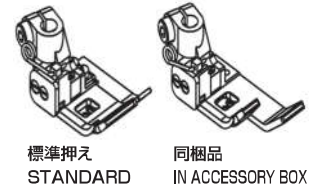

標準押え
STANDARD

同梱品
IN ACCESSORY BOX

MODEL	No. of Needle	No. of Thread	Needle Type		Gauge (Inch)	No. of Stitch (Stitch/Inch)	Diff. Feed Ratio	Presser Foot Lift (mm)	Needle Bar Stroke (mm)	Max. Speed (rpm)
			Organ (#)	Schmetz (Nm)						
NR9803GALK	3	5	UYX128GAS 9~14	UYX128GAS 60~90	7/32, 1/4	6~16 (1.6~4.2mm)	0.3~2.9	5500	33 (31↔33)	5500
NR9803GALK-UTA										

NR OTHER MODELS TECHNICAL DATA 仕様明細

MODEL	No. of Needle	No. of Thread	Needle Type		Gauge (Inch)	No. of Stitch (Stitch/Inch)	Diff. Feed Ratio	Upper Feed Amount (mm)		Presser Foot Lift (mm)	Needle Bar Stroke (mm)	Max. Speed (rpm)
			Organ (#)	Schmetz (Nm)				↔	↑↓			
NR9804GD	4	6	SM1014H #10S	SM1014H #70	6mm, 6.4mm	6~16 (1.6~4.2mm)	0.3~2.9	/	/	6	31	4000
NR9804GD-UTA												
NR9803GPLK	3	5	UYX128GAS 9~14	UYX128GAS 60~90	7/32, 1/4	6~16 (1.6~4.2mm)	0.3~2.9	/	/	6	33 (31↔33)	4800
NR9803GPLK-UTA NR9803GPLK-UTE												

RX-UF MODELS TECHNICAL DATA 仕様明細

RX9802A-UF	2	4	UYX128GAS 9~14	UYX128GAS 60~90	3/16	6~16 (1.6~4.2mm)	0.3~2.9	1~7	3.5~6	6	33	5500
RX9803A-UF	3	5			7/32, 1/4							
RX9802A-UF/UTC-A/E RX9802A-UF/UTC-AW/EW	2	4			3/16							
RX9803A-UF/UTC-A/E RX9803A-UF/UTC-AW/EW	3	5			7/32, 1/4							

※ Upper feed machines are only available for RX series

INDUSTRIAL SEWING MACHINES
PRODUCTS GUIDE

TOP & BOTTOM

NW・WX・NL SERIES

KC SERIES

NR・NRE・RX・UF SERIES

NC・NM・UF SERIES

NFS SERIES

NRE9803GCC



3本針両面飾り縫いセミシリンダー外部
ハマグリ機構マシン
マルチゲージ(A,D,C,CL)

3 needle, cylinder bed, top and
bottom cover stitch machine with
exterior looper thread takeup cam
(4 type gauge set included)

3 agujas, cama del cilindro, cima
y máquina de puntada de tapa de
fondo con looper exterior enhebran
la toma a la leva (4 juegos de
medida de tipo incluyeron)

小方头 3 针 5 线绷缝机, 打线拖轮外置式
多用途针位 (下摆, 基本缝, 立骨, 倒骨)

MODEL	No. of Needle	No. of Thread	Needle Type		Gauge (Inch)	No. of Stitch (Stitch/Inch)	Diff. Feed Ratio	Presser Foot Lift (mm)	Needle Bar Stroke (mm)	Max. Speed (rpm)
			Organ (#)	Schmetz (Nm)						
NRE9803GCC	3	5	UYX128GAS	UYX128GAS	7/32, 1/4	6~16 (1.6~4.2mm)	0.3~2.9	6	31 (31↔33)	6000
NRE9803GCC-UTA			9~14	60~90						
NRE9803GCC-UTE										

NRE9803GP



P - Gear puller
PE - Smooth puller



3本針両面飾り縫いセミシリンダー、外部
ハマグリ機構プーラー、ゴム入れ用ミシ
ン

3 needle, cylinder bed, top and
bottom cover stitch machine with
exterior looper thread takeup cam
with rear puller for attaching elastic

3 agujas, cama del cilindro, cima
y máquina de puntada de tapa de
fondo con looper exterior enhebran
la toma a la leva Para pegar
elastico, con arrastrador

小方头 3 针 5 线绷缝机, 打线拖轮外置式,
带后拖轮

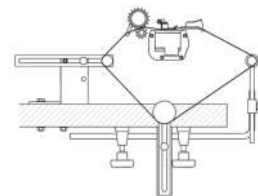

同梱品 / IN ACCESSORY BOX

MODEL	No. of Needle	No. of Thread	Needle Type		Gauge (Inch)	No. of Stitch (Stitch/Inch)	Diff. Feed Ratio	Presser Foot Lift (mm)	Needle Bar Stroke (mm)	Max. Speed (rpm)
			Organ (#)	Schmetz (Nm)						
NRE9803GP	3	5	UYX128GAS	UYX128GAS	7/32, 1/4	6~16 (1.6~4.2mm)	0.3~2.9	6	33 (31↔33)	4800
NRE9803GP-UTA			9~14	60~90						

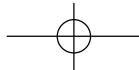

NRE9803GMG

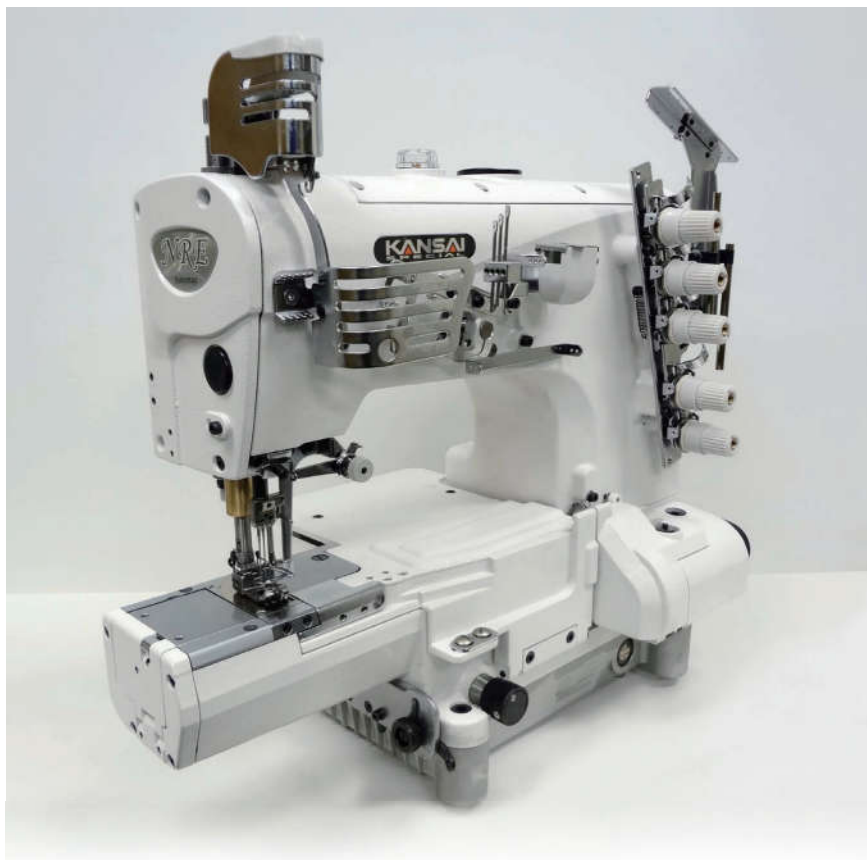

3本針両面飾り縫い外部ハグリ機構
マシン
マルチゲージ(A,D,C,CL,F)

3 needle, cylinder bed, top and
bottom cover stitch machine with
exterior looper thread takeup
cam(5 type gauge sets included)

3 agujas, cama del cilindro, cima
y máquina de puntada de tapa de
fondo con looper exterior enhebran
la toma a la leva (5 juegos de
medida de tipo incluyeron)

3 针两面缝装饰绷缝机 (筒式台, 打线器
设定在外边, 可以选各种针位)



Tape binding / Pegar cinta / 滚条

MODEL	No. of Needle	No. of Thread	Needle Type		Gauge (Inch)	Nc. of Stitch (Stitch/Inch)	Diff. Feed Ratio	Presser Foot Lift (mm)	Needle Bar Stroke (mm)	Max. Speed (rpm)
			Orgen (#)	Schmetz (Nm)						
NRE9803GMG	3	5	UYX128GAS	UYX128GAS	7/32, 1/4	6~16 (1.6~4.2mm)	0.3~2.9	6	31 (31↔33)	6000
NRE9803GMG-UTA NRE9803GMG-UTE			9~14	60~90						

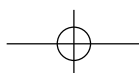

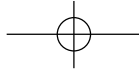

■ **D type Plain / Puntada regular / 辅助平台**
Plain

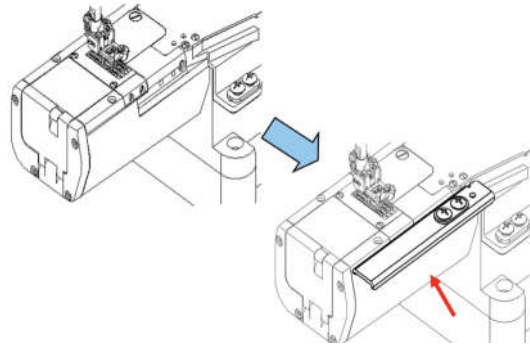

■ **C/GL type Covering / Cubrir costuras de overlock / 盖缝**
Plain to Covering

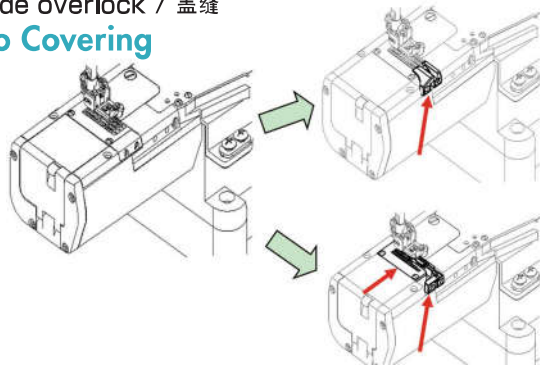

■ **F type Tape binding / Pegar cinta / 滚条**
Plain to Tape binding

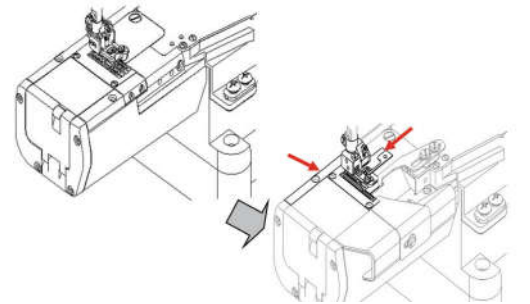

■ **A type Hemming / Doblado / 折下摆**
Plain to Hemming

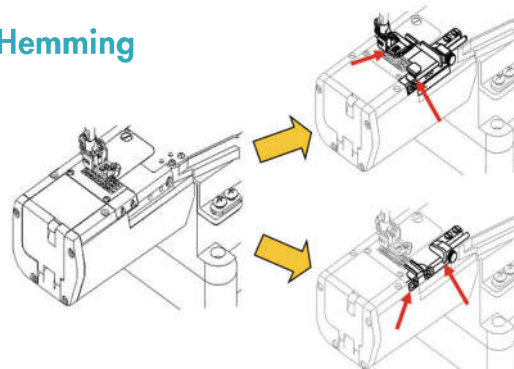

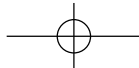

NC SERIES

NCシリーズは、超極細シリンダーベッド(外周180mm)、高速・高性能両面飾り偏平縫いミシンです。
 子供服、ベビー服などの袖口のカバーリング、ヘム縫い、首周り、婦人用ストッキング、ショーツなどの縫製に最適です。差動送り装置付きですので、伸縮性のある素材もきれいに仕上がります。

NC series is an ultra small cylinder bed (circumference 180mm), top and bottom cover stitch machine for high speed and reliable performance. Applications: overlock cover seaming and hemming. Major features of this series are ultra small cylinder bed, differential feed mechanism and micro adjust stitch regulator. NC series is well suited for sewing sleeve cuffs, neck opening of infants' clothing, children's clothing, as well as ladies' stockings.

NC serie de alta velocidad con recubridor, superior e inferior, cilindro pequeño (circunferencia 180mm). Esta maquina es la ideal para coser mangas, punos, cuello, en ropa de niño (ribete y recubridor) medias para senora, etc. Esta serie produce terminados muy buenos, incluyendo en telas estrechables, porque esta equipada con mecanismo de alimentador diferencial.

NC 系列为超級细筒式(外周 180mm) 高速, 高性能两面縲缝机。儿童服装的袖口, 包边, 领口, 妇女的裤袜等最为合适, 带差动送布, 也可以缝伸缩性的布料。

NCモデル表示方法

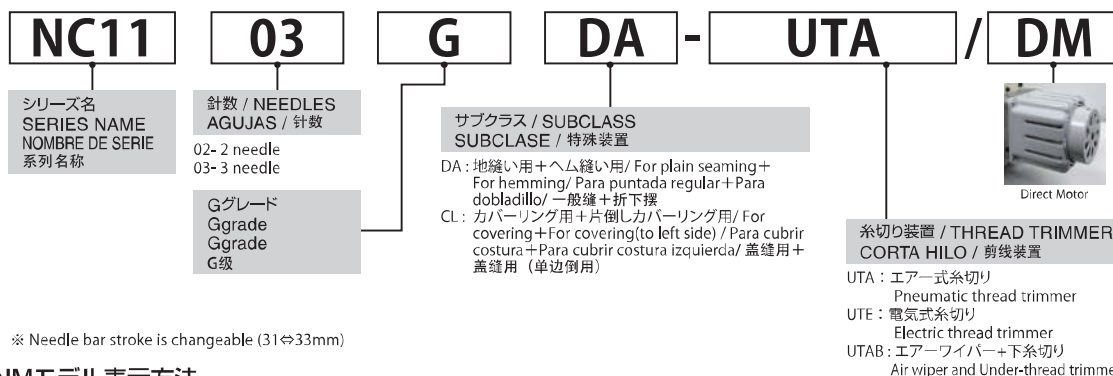

NMモデル表示方法

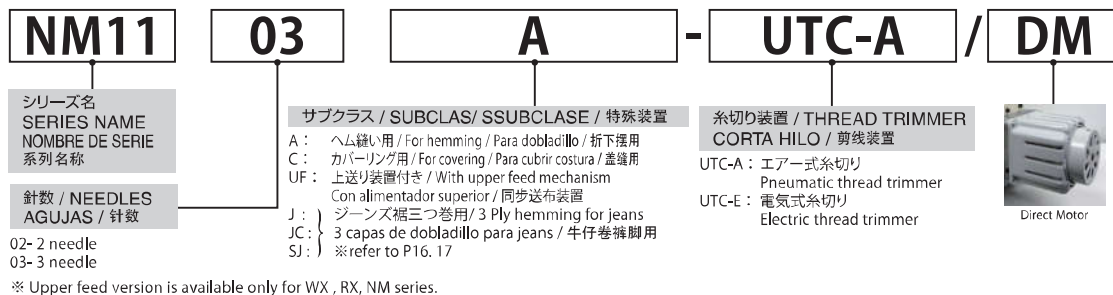

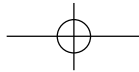

INDUSTRIAL SEWING MACHINES PRODUCTS GUIDE

TOP & BOTTOM

NW・WX・NL SERIES

KC SERIES

NR・NR・RX・UF SERIES

NC・NM・UF SERIES

NFS SERIES

NC1103GDA-UTE

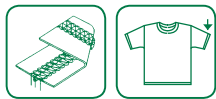

3本針極細シリンダーベッド偏平縫いヘム縫い用マルチゲージミシン(D,A)

3 needle, ultra small cylinder bed, top and bottom cover stitch machine for hemming and plain seaming

3 agujas, cama cilíndrica pequeña, recubridor superior e inferior para dobladillo (2 juegos de medida de tipo incluyeron)

3 针两面装饰卷边用缝线机

MODEL	No. of Needle	No. of Thread	Needle Type		Gauge (Inch)	No. of Stitch (Stitch/Inch)	Diff. Feed Ratio	Presser Foot Lift (mm)	Needle Bar Stroke (mm)	Max. Speed (rpm)
			Organ (#)	Schmetz (Nm)						
NC1103GDA										
NC1103GDA-UTA										
NC1103GDA-UTE										
	3	5	UYX128GAS 9~14	UYX128GAS 60~90	7/32, 1/4	7~16 (1.6~3.6mm)	0.8~1.4	6	33 (31⇔33)	4500

NC1103GCL-UTA

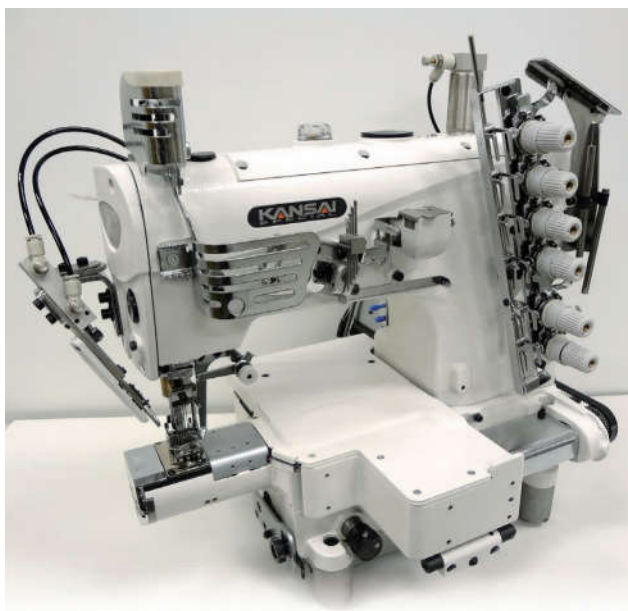

3本針極細シリンダーベッド偏平縫いカバーリング用ミシン

3 needle, ultra small cylinder bed, top and bottom cover stitch machine for covering left fold of overlock seams

Cama cilíndrica, 3 agujas, recubridor superior e inferior, con cortador de hilos automáticos para coser la costura previa de overlock, para la mejor calidad de la prenda

3 针两面装饰单面倒盖缝及中间缝两用缝线机

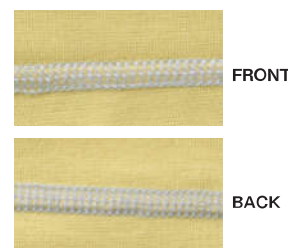



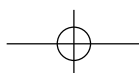

MODEL	No. of Needle	No. of Thread	Needle Type		Gauge (Inch)	No. of Stitch (Stitch/Inch)	Diff. Feed Ratio	Presser Foot Lift (mm)	Needle Bar Stroke (mm)	Max. Speed (rpm)
			Organ (#)	Schmetz (Nm)						
NC1103GCL										
NC1103GCL-UTA										
NC1103GCL-UTE										
	3	5	UYX128GAS 9~14	UYX128GAS 60~90	7/32, 1/4	7~16 (1.6~3.6mm)	0.8~1.4	6	33 (31⇔33)	4500





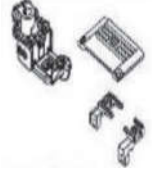

GDA / GCL 比較 / Comparison / Comparacion / 相比

(The following parts for versatile operation are included / Se incluyen las siguientes piezas para un funcionamiento versatil / NC系列为多用途缝纫机，以下零件装入附件箱里面)

DA SERIES

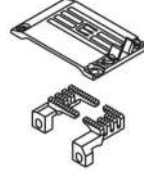
 D TYPE	 STANDARD	
 A TYPE	 IN ACCESSORY BOX	

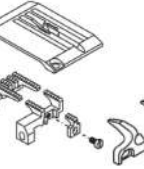
CL SERIES

 CL TYPE	 STANDARD	
 C TYPE	 IN ACCESSORY BOX	

**NC1001SJ
NC1001J**



1本針2重環縫い極細シリンダー裾三ツ巻用ミシン

1 needle, cylinder bed, double chain stitch machine with 3 ply hemming folder

1 aguja, cama cilíndrica, con doble puntada de cadeneta con folder para dobladillos de 3 capas

单针链式缝小细嘴脚踏机

For NM1001J Needle plate guides are available for various denim weights
※Please refer to the right table (front view → foot → stepping sewing parts)



NC1001J

Jタイプは上送りローラーと生地段差調整プレート付き左右差動送り機構により縫いずれを防ぎながら強力な送りで縫製できます。(生地の厚みにより補助針板を換えて下さい。)

Equipped with the new top feed mechanism and left and right differential feed dog mechanism, so that "J-series" sew cross seam sections smoothly especially for extra-heavy jeans. (Various types of needle plate support are available according to fabric thickness.)

Equipado con el nuevo mecanismo de alimentación de la parte superior y mecanismo transportador diferencial izquierda y derecha de modo que "la serie "j" cose las costuras transversales sin problemas especialmente para los pantalones jeans extrapesados. (Varios tipos de soporte de la placa de agujas están disponibles en función del espesor de la tela.)

J型采用上送布轮和左右差动结构，可防止缝制时的布料的错位和以强有力的送布力度进行缝制 (按照布料的厚薄可换辅助针板)

左右差動送り機構 / Left and right differential feed dog mechanism / Mecanismo de transporte diferencial izquierdo y derecho / 左右差動結構

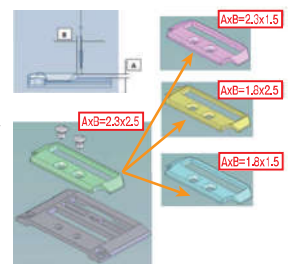

NC1001SJ

SJタイプはφ65mmの極細シリンダーとトラクタフット、差動送りで女性用のジーンズに最適です。

Equipped with φ65mm cylinder, tractor foot, differential feed, NC1001SJ is specialized for women's jeans

NC1001SJ, especializada para Jeans de Mujer. Está equipada con un cilindro de 65mm, pie tractor y pie diferencial (Arrastre).

SJ型为周围65毫米的小细嘴机壳，带特制高低压脚和差动功能，最适合于女装牛仔裤的缝制



前後差動送り機構 / Front and back differential feed dog mechanism / Mecanismo de transporte diferencial frontal y posterior / 前后差動結構





NC1001J-CD-UTC-AB※

自動糸切り、コンデンスステッチ機能付マシン
With condense stitch function and under thread trimmer
Con puntada condensada y corta hilo neumatico
带自动剪线装置、密缝功能
*NC1001J will be changed from NM1001J soon.

NC-J, NC-SJ SERIES TECHNICAL DATA 仕様明細

MODEL	Subclass	Circumference (mm)	No. of Needle	No. of Thread	Needle	No. of Stitch (Stitch/Inch)	Diff. Feed Ratio		Teeth Pitch	Presser Foot Lift (mm)	Upper Feed Roller	Needle Bar Stroke (mm)	Max. Speed (rpm)	Stepped Sewing Parts	
							Front	Back						Front View	Remarks
NC1001	J	266 (with guide roller) ≥ Φ85	1	2 max #8	TVX5 #14~ 22	6~11 (2.3~4.2mm)	-	0.8-1.2	1.6	10	-	34	3000	 6.2mm adjustable A x B 2.3 x 2.5 (standard) (option) 2.3 x 1.5 1.8 x 2.5 1.8 x 1.5	
	J-UTC-AB														
	J-CD-UTC-AB														
	SJ	195 (none guide roller) ≥ Φ65	1	2~3 max #8	TVX5 #14~ 23	6~11 (2.3~4.2mm)	0.8-1.2	option	2.54	9	-	34	3500	 1mm 3mm	
	SJC														
SJ-UTC-AB SJC-UTC-AB															

C : コンデンスステッチ機能付 / With condense stitch function / Con función de puntada condensada / 带密缝装置
F : FOLDER (SJF, SJCF)

NM-UF SERIES TECHNICAL DATA 仕様明細

MODEL	No. of Needle	No. of Thread	Needle Type		Gauge (Inch)	No. of Stitch (Stitch/Inch)	Diff. Feed Ratio	Upper Feed Amount (mm)		Presser Foot Lift (mm)	Needle Bar Stroke (mm)	Max. Speed (rpm)
			Organ (#)	Schmetz (Nm)				←	↑			
NM1102A-UF NM1102C-UF	2	4	UYX128GAS 11~14	UYX128GAS 60~90	3/16	7~16 (1.6~3.6mm)	0.8~1.4	1~7	3.5~6	6	33	4500
NM1103A-UF NM1103C-UF	3	5			7/32, 1/4							
NM1102A-UF/UTC-A/E NM1102C-UF/UTC-A/E	2	4			3/16							
NM1103A-UF/UTC-A/E NM1103C-UF/UTC-A/E	3	5			7/32, 1/4							
NM1103CL-UF/UTC-A/E												

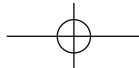

NFS SERIES

NFSシリーズは、フラットシーム用4本針6本糸両面飾り腕送り出し偏平縫いミシンです。

高級下着やスポーツウェアなどの継ぎ合わせ、ブリーフの股下合わせ等に適しています。

片切りまたは両切りの生地カットによるごろつきのないフラットな仕上がりや股合わせ縫いの段部での縫製など、薄物～厚物まで様々な用途に対応するためにバリエーションも豊富に揃えております。

腕送り出し型ですので、筒物や丸物の作業に適しています。

NFS series, 4 needle, 6 thread, feed-off-the-arm, top and bottom cover stitch machine. This machine is suitable for overlapping such as joining of high quality under wear, sport wear and inseaming of brief. Equipped with one side cut or both side cut trimmer, this system guarantees flat shape neat finish completely, in order to materialize versatile applications from thin to heavy materials such as inseaming of brief's cross seams. Design of this feed-off-the-arm is perfect for tubular garments.

La serie NFS de 4 agujas y 6 hilos, alimentacion de brazo, recubridor superior y inferior. Esta maquina es apropiada para sobrecoser y juntar ropa interior y deportiva. Equipada con corte par uno y dos lados, este sistema garantiza un terminado completamente nitido. Para aplicaciones versatiles, de materiales livianos o pesados, apropiado para coser donde hay sbrecosturas, alimentacion de brazo, es perfecto para prendas tubulares.

NFS 系列，拼缝用两面装饰线迹 4 针 6 线双切式伸出手臂式绷缝机高级内衣裤，运动装等缝制边时拼合左右的布料边缝制，也适合公事包的下挡拼合缝等通过单片切和两片切，缝制边时拼合左右的布料边缝制，缝制重叠部分是一定的，缝成后非常美观。从薄布料到中厚布料的各种各样的加工种类因为是伸出手臂型，所以适合筒物和圆物的加工

NFSシリーズ 表示方法

NFS66

シリーズ名
SERIES NAME
NOMBRE DE SERIE
系列名称

04

針数
NEEDLES
AGUJAS
針数

04: 4本針
4 needle
4 agujas
4針

G

Gグレード
Ggrade
G級

LM

用途
OBJECT
APLICACION
他機種参照

S: 片切り
Trimming left side edge.
Borde del lado izquierdo arreglando
单切刀

SL: 片切り+テープ付
Trimming left side edge with tape attaching,
corte de un solo filo + Pegar cintas
单切+拉贴条

LM: 薄物～中厚物
For light to medium fabric.
Para la luz al tejido pesado elemento
薄布料到中厚布料用

MH: 中厚物～厚物
For medium to heavy fabric.
Para el tejido pesado elemento
al tejido pesado
中厚布料到厚布料用

MH-B: 厚物突合せ
For butt seaming.
Por extremo coser
厚料接缝

CS-2

オプション
OPTIONS
OPCION
选项

CS-2: 電気式空環切り装置
Electric chain cutter
Cortador de cadeneta
气动式切空线环装置

DD: ダイレクトモーター
Direct motor
Motor directo
直驱马达



NFS series

FSXは油もれ防止の機能が向上した新モデルNFSに刷新されました。
FSX has been modified to NFS series with new oil protection equipment.
FSX ha sido modificado a la serie NFS, con nuevo equipo para protección de aceite.
原来的FSX升级为提高防漏油功能的新款NFS。

NEW OIL PROTECTION SYSTEM

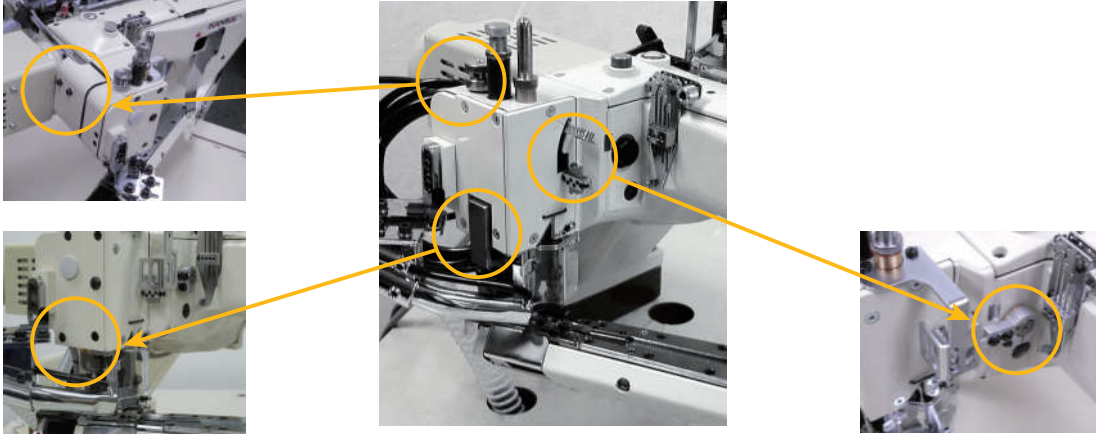

NFS6604GS



NFS6604GS

4本針上飾り付片切り式フラットシーマ
(薄～中厚用) ブリーフの股縫ぎ、Tシャツの袖閉じ縫い用、
一般的には生地左側をカットします。

4 needle, with top cover stitch, single edge cut type
flat seamer
For joining the crotch of brief and T-shirts sleeves

4 agujas recubridor superior, corte sencillo de
borde en costura, plana, union de costura, entre-
pierna, y mangas de camiseta

4 针 6 线单切拼缝缝纫机
最适合于男士内裤等的缝制。

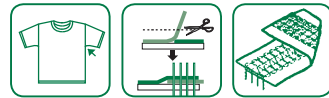

NFS6604GSL

NFS6604GSL

4本針下面飾り片切り式フラットシーマブリーフのテープ付けなどに最適です。
4needle, with bottom cover stitch, single edge cut seamer with tape attaching for men's brief
4 agujas, con recubrimiento inferior, corte de un solo filo
单切4针6线拼缝缝纫机最适合于男装内裤拉贴条等。

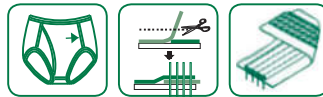

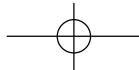

NFS6604GLM-DD

4本針上飾り付き両切り式フラットシーマ(薄~中厚用)。
Tシャツの肩縫ぎ、身頃の縫ぎ合わせ用。両切り押えにより左右の生地をカットしながら縫いずれなくきれいに縫い合わせることができます。

4 needle with top cover stitch, both side edge cut type flat seamer
Suitable for joining the cloth of brief and T-shirt sleeves
Both side edge trimmer can solve the puckering of material cutting and get a beautiful stitch formation.

4 agujas, recubridor superior, corte de borde en los dos lados. Union de costura, entre-pierna, y mangas de camiseta, al tener corte en los dos lados, no permite que el material forme arrugas, para una formación de puntada muy bonita.

4 针 6 线装饰线迹田臂单切式拼缝机带双片切
(薄布料到中厚布料用)

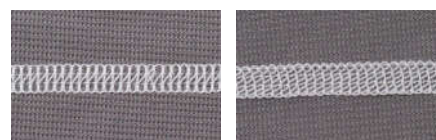
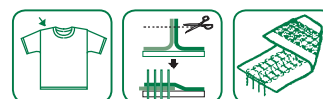

FRONT

BACK



NFS6604GMH-DD/CS-2

4本針上飾り付両切式フラットシーマ(中厚~厚物用)。
ブリーフの股合わせの段部や厚物の合わせ縫いにも縫いずれ縫いはずれなくきれいに縫い合わせることができます。

4 needle, with top cover stitch, both side edge cut type flat seamer
Suitable for the closing the crotch of brief with thick parts like a tape binding and heavy material

4 agujas, recubridor superior corte de borde en ambos lados, costura plana, para cerrar costura de entre- - piernas, con cinta en materiales pesados

4 针 6 线装饰线迹田臂单切式拼缝机
(中厚布料到厚布料)

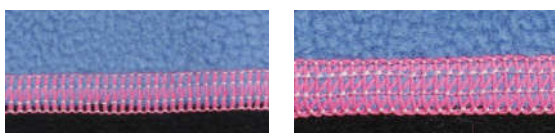

ダイレクトモーター仕様は標準装備
Digital pulley is inclusive in the direct drive motor package

NFS6604GMH-B-DD/CS-2

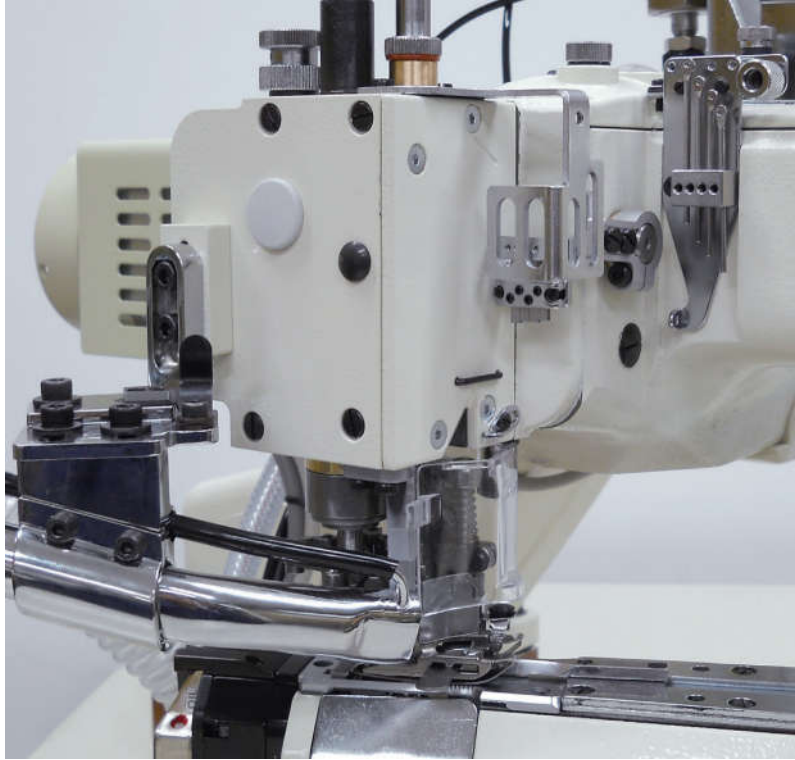

4本針上飾り付両切式突合せ縫い用フラットシーマ
(中厚～厚物用)
トレーナー生地やフリースなどの厚物地の左右生地
を全く重ねない突合せ縫いにより縫いはずれなくよ
りフラットで着心地のよいきれいに縫い合わせでき
ます。

4 needle, with top cover stitch, both side
edge cut type flat seamer for butt seams
Suitable for joining heavy materials without
overlapping fabrics, so that the seams can
be more flat and beautiful stitch formation









4 agujas, recubridor superior corte de borde en
ambos lados, costura plana, para union plana,
sin coser sobre arriba de esta manera la costura
es mas plana y la puntada mas bonita

4 针 6 线上装饰线迹布边对布边不重叠缝曲臂双切
式缝机

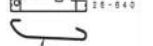

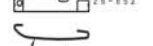



■ 押えシューズの種類 / NFS PRESSER FOOT SHOES / NFS Zapatos de prensa tela / 压脚种类

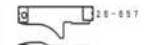

標準装備 / STANDARD EQUIPMENT / Equipo normal / 标准配件

LM-52, 60	MH-52, 60	S-52, 60
 28-841	 28-844	 28-853
 28-840	 28-843	 28-852
 0.3mm	 0.3mm	 0.4mm

同梱品 / Enclosed / Incluido / 配备品

LM-52, 60	MH-52, 60
 28-857	 28-857
 28-856	 28-856
 0.4mm	 0.4mm

■ 布ガイドの種類 / LAP FORMER / Guía de tela / 导轨

LM-52, 60	MH-52, 60	OPTION
 28-859	 28-857	 28-857

■ 押えの比較 /

Comparison between the pressure foot LM type and MH type /
Comparacion entre pie de presion LM y MH / 押脚比较



LM



MH

MHの押さえのナイフはLMのもの比べて上の写真のような厚い生地を切る為、
更に幅が厚くなっています。

The knife of MH pressure foot is much wider than LM in order to cut
heavy material like a picture above

El cuchillo MH del pie de presion es mas ancho que el LM para cortar
material mas pesado. Ver foto

MH和LM押脚的别是MH押脚能剪厚布(如布样照片)甚至更厚的布料



MH-B



S

MODEL	No. of Needle	No. of Thread	Needle Type	Gauge (mm)	No. of Stitch (Stitch/Inch)	Diff. Feed Ratio	Presser Foot Lift (mm)	Needle Bar Stroke (mm)	Max. Speed (rpm)
			Organ (#)						
NFS6604GS	4+1	6	FLX118GCS 9~12(10) / FLG-8 8	5.2, 6	10~16 (1.6~2.5mm)	1:0.7~1:1.5	8	30	4200
NFS6604GLM									
NFS6604GMH									
NFS6604GMH-B									

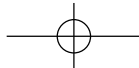

PX・MAC SERIES

PXシリーズは、フラットベッド、1本針、2本針二重環千鳥縫いミシンです。

4種類のカム、ゲージを揃えており、2点、3点、4点、5点と千鳥模様を選ぶことができます。また、ピコット縫い、ファゴッティング、さらに新モデルの飾り松葉縫い(フラワーピコット)もラインナップに追加され、婦人服、子供服、ハンカチ、テーブルクロスなどの製品の飾りに最適で、付加価値のある製品に仕上がります。

MAC-100シリーズは、飾り縫いミシンのハイエンドモデルです。当社PXシリーズの4点千鳥でジグザグ模様と飾り松葉縫いを電子制御により多種多様に組み合わせてお客様自身が好みの模様を創造することができる画期的な製品です。

Tシャツ、ニットウェア、ハンカチなどの縁かがりに使用すれば、独創的な製品が出来上がります。

PX series is flatbed, 1 or 2 needle double chain stitch machine for achieving wishful design. This machine performs zig-zag by the built-in cam that moves the needles left and right (2-5 points). Applications: various designs using picotting and fagotting. Furthermore, newly developed flower stitching machine (Flower Picot) is joined to this series as new model. The outstanding feature of PX is wide variety of decorative stitch patterns using picotting and fagotting. PX series is our best machine for not only women's and children's clothing but also handkerchiefs, table napkins. Your wishful design starts to realize with PX series.

MAC-100 series is a high-end model of decorative stitch machine. This series is epochmaking of PX 4 points zig-zag having a great variety of combination between zig-zag design and flower picotting by electric system. Standard model can be used on the edge of T-shirt, knitwear, handkerchief, etc.

Cama plana 1 o 2 agujas, doble cadeneta picaoeta, 4 diferentes levas, y varias medidas, Zig-Zag patrones de 2 a 5 puntos para puntadas decorativas, incluyendo la puntada de flor exclusiva de Kansai Special, esta serie es especial para embellecimiento de ropa para senoras, ninos, panuelos, etc.

La serie MAC-100 es una maquina modelo de alta calidad de puntadas decorativas. Esta serie es una maquina Zig-Zag PX de 4 puntos que tiene una gran variedad de combinaciones entre disenos Zig-Zag y puntada de flor por sistemas electricas. El modelo estandar puede ser cosido en el borde de playeras, tejidos, panuelos, etc. y tambien es posible ser cosido por puntadas decorativas completas cambiando algunas partes.

PX 系列是平台式 1 针, 2 针双重环外曲牙缝纫机。4 种齿轮, 针位能缝 2 点, 3 点, 4 点, 5 点外曲牙。

外曲牙, 花形外曲牙, 另外追加了新型的松叶状花形, 最适合女装, 童装, 手帕, 桌布等有附加价值的产品的装饰缝。

MAC-100 系列是装饰缝的高技术型缝纫机。

本公司的 PX 系列的 4 点外曲牙和花形外曲牙通过电子控制产生各种组合花形, 供客户选用。

标准型为各种布料的外边缝, 一部分零件交换后可用于布料中的装饰缝。

PXシリーズ 表示方法

PX

シリーズ名 / SERIES NAME
NOMBRE DE SERIE / 系列名称

302

針数 / NEEDLES
AGUJAS / 针数

301:1本針
1 needle
1 agujas
1針

302:2本針
2 needle
2 agujas
2針

4

千鳥数 / ZIG-ZAG POINTS
NUMERO DE ZIGZAG / 曲牙数

2:2点千鳥
2 points zig-zag
2 puntos de zig-zag
2点曲牙

4:4点千鳥
4 points zig-zag
4 puntos de zig-zag
4点曲牙

5:5点千鳥
5 points zig-zag
5 puntos de zig-zag
5点曲牙

W

サブクラス / SUBCLASS
SUBCLASE / 特殊装置

S:1本針シングルピコット
Single picotte by 1needle
Picueta simple en 1 aguja
1針曲牙

W:2本針ダブルピコット
Double picotte by 2 needles
Picueta doble en 2 agujas
2針曲牙

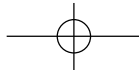

INDUSTRIAL SEWING MACHINES PRODUCTS GUIDE

DECORATION

PX•MAC SERIES

MMX SERIES

PX302-4W

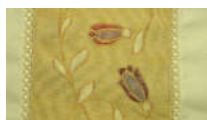
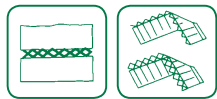

2本針二重環縫い4点千鳥用マシン

2 needle, double chain stitch,
4-point zig-zag machine.

2 agujas, doble cadeneta, 4 puntos
de zig-zag.

2 针双重环缝，4 点曲牙缝缝纫机



MODEL	No. of Needle	No. of Thread	Needle Type		Gauge (Inch)	No. of Stitch (Stitch/Inch)	Diff. Feed Ratio	Presser Foot Lift (mm)	Needle Bar Stroke (mm)	Max. Speed (rpm)
			Organ (#)	Schmetz (Nm)						
PX302-4W	2	4	UO×163 11	UY×163GAS 75	2X5.55mm(総振り巾)	0.9mm	0.8~1.5	8	31	3500
PX302-5W	2	4	UO×163 11	UY×163GAS 75	2X7.4mm(総振り巾)	0.9mm	0.8~1.5	8	31	3000

PX301-2S



1本針二重環2点千鳥マシン

1 needle, double chain stitch,
2-point zigzag machine

1 aguja, doble cadeneta, 2 puntos
de zigzag.

1 针双重环缝，2 点曲牙缝缝纫机



MODEL	No. of Needle	No. of Thread	Needle Type		Gauge (Inch)	No. of Stitch (Stitch/Inch)	Diff. Feed Ratio	Presser Foot Lift (mm)	Needle Bar Stroke (mm)	Max. Speed (rpm)
			Organ (#)	Schmetz (Nm)						
PX301-2S	1	2	UO×163 11	UY×163GAS 75	3.5mm(総振り巾)	1.75mm	0.8~1.5	8	31	3000

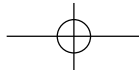

PX302-5W

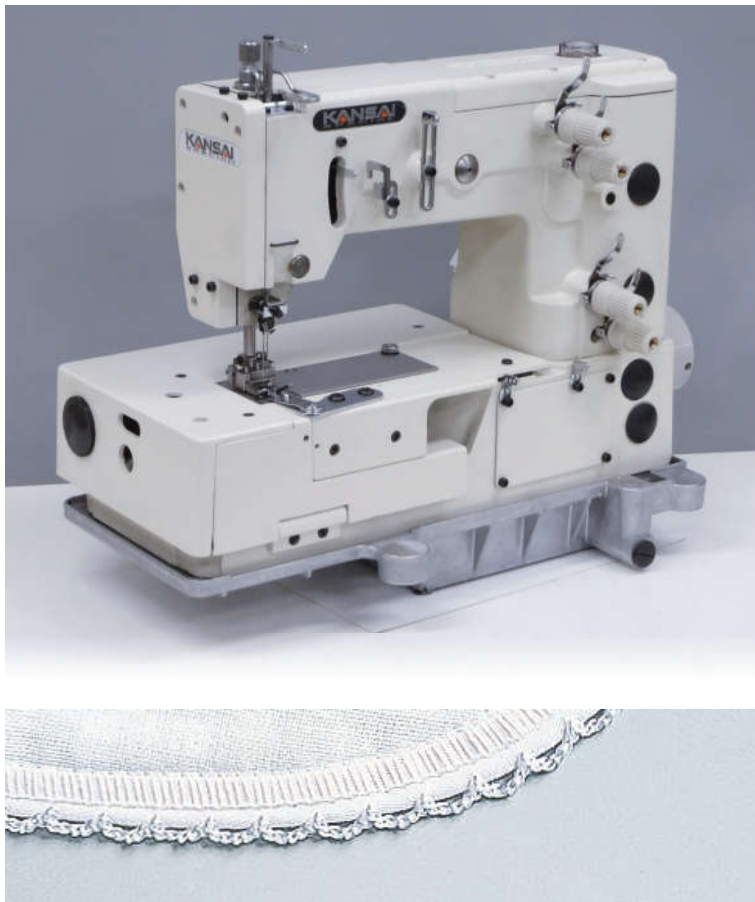

2本針二重環5点千鳥ミシン

2 needle, double chain stitch, 5-point zigzag machine.

2 agujas doble cadeneta; 5 puntos (4 pasos) maquina de zig-zag.

2 针双重环缝，5 点曲牙缝纫机

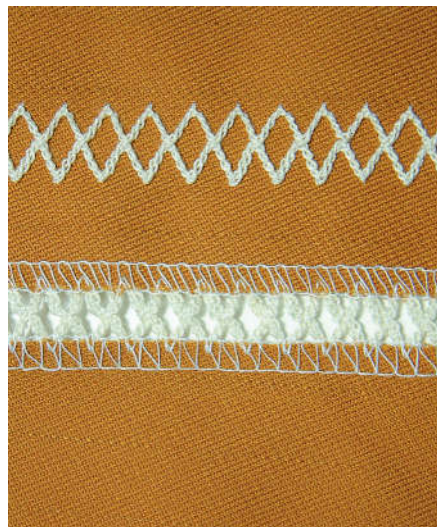
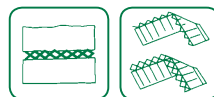

PX302

-

4W

•

5W

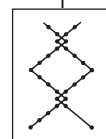
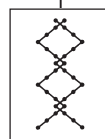

SINGLE PICOTTING

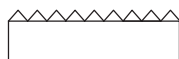

DOUBLE PICOTTING

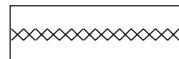

FAGOTTING

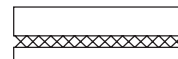

MAC100



飾り縫いのハイエンドモデルです。PXシリーズの4点千鳥でジグザグ模様と飾り松葉縫いを電子制御により多種多様に組み合わせてお客様自身がお好みの模様を作り出すことができる画期的な商品です。

High end model of decorative stitch machine. Epock making of PX 4 points zig-zag having a great variety of combination between zig-zag design and flower picotting by electric system.

Una maquina modelo de alta calidad de puntadas decorativas. Zig-zag PX de 4 puntos que tiene una gran variedad de combinaciones entre direnos zig-zag y puntada de flor por sistema eletrica.

电子外曲牙和花型机
外曲牙和花形缝的组合，产生各种花样缝，通过电子控制产生各种装饰缝花样。

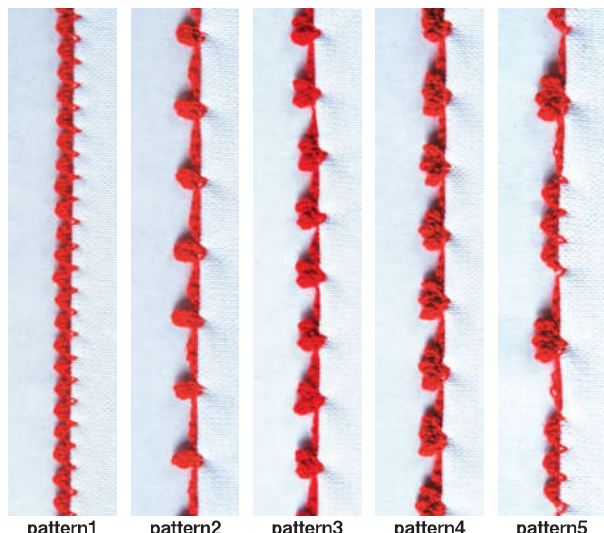

pattern1 pattern2 pattern3 pattern4 pattern5

MODEL	No. of Needle	No. of Thread	Needle Type		Gauge (Inch)	No. of Stitch (Stitch/Inch)	Diff. Feed Ratio	Presser Foot Lift (mm)	Needle Bar Stroke (mm)	Max. Speed (rpm)
			Organ (#)	Schmetz (Nm)						
MAC100	1	2	UO×163 11	UY×163GAS 75	5.55mm(総振り巾)	1	0.8~1.5	8	31	2000

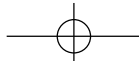

MMX SERIES

飾り縫いには定評があるKANSAI SPECIALから、より高速で安定性のある新しいスモック飾り縫いミシンが誕生しました。婦人服、子供服、下着、スポーツウェア等の地縫いおよびテープ付け縫いに最適です。

従来モデルはカムの種類が3種類でしたが、このMMXシリーズでは更に3種類を追加し、計6種類のカムを用意しています。

また、そのカムの交換も非常に簡素化され、カムの振り板(スプレッダー)を微調整する必要をなくしました。振り板を上下2段式にすることによりスモッキング糸が生地に対してより自然にフィットします。

This new smocking machine with high speed and stabilized performance is just released from KANSAI SPECIAL who has a reputation in the field of decorative sewing machine. Most suitable for hemming and taping such as lady's wear, children's wear, underwear, sportswear and so on. 6 kinds of standard cams are available as the conventional model. Very easy to change the cam. No need to adjust the spreaders. The smocking threads fit with the fabric naturally by adopting dual oscillating spreaders.

Esta es nueva maquina de puntada decorativa(smocking) de alta velocidad, KANSAI SPECIAL. Acaba de introducirla al mercado es indicada para ropa de senora, ninos, ropa deportiva. 3 clases de leva son standar en los modelos convencionales, en esta serie nueva de MMX hay 3 levas opcionales, para hacer diferentes aplocaciones, y es muy facil hacer el cambio de leva, no es necesario ajustar los esparcidoses. El hilo para la puntada decorativa, se adopta a la tela muy facilmente, debido a que tiene 2 etapas de los esparcidoses de arriba, y abajo.

装饰缝收到好评的 KANSAI 开发出更高速的安定性强的新装饰缝的缝纫机。用于女装，童装，内衣，运动服等服装，并可于于滚领。

MMX系列在以前的3种花盘的基础上追加了3种花盘。并且花盘交换简易化，不需要做微调整。装饰板上下两段分开，使装饰缝迹更与布料吻合。

MMXシリーズ 表示方法

MMX

シリーズ名
SERIES NAME
NOMBRE DE SERIE
系列名称

33

03

針数
NEEDLES
AGUJAS
针数

03:3本針
3 needles
3 agujas
3針

F

サブクラス
SUBCLASS
SUBCLASSE
特殊装置

D:標準
Standard
Estandar
标准

F:テープ付け用
For binding tape
Para pegar cinta
滚领用

MMX3303F

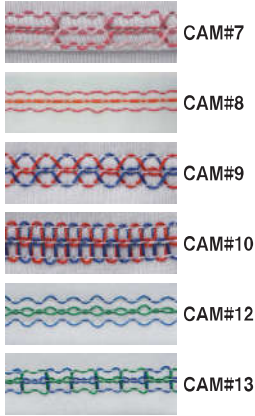

3本針下面飾りテープ付け用スモッキング
グミシン

3 needle, bottom cover stitch
machine with smocking for tape
binding.

3 agujas, recubridor inferior,
puntada decorativa para pegar
cintas.

3 针装饰缝滚领缝纫机



MODEL	No. of Needle	No. of Thread	Needle Type		Gauge (Inch)	No. of Stitch (Stitch/Inch)	Diff. Feed Ratio	Presser Foot Lift (mm)	Needle Bar Stroke (mm)	Max. Speed (rpm)
			Organ (#)	Schmetz (Nm)						
MMX3303F	3	6~10	UYX128GAS 9~14	UYX128GAS 60~90	7/32, 1/4	8~16	0.7~2	6	31	3500

カムの種類及び模様 | Smocking Description / Descripción de Smocking / 模盘的种类和缝制模样

飾り糸ループ* - (上) / Top Smocking Looper
 飾り糸ループ* - (下) / Bottom Smocking Looper

飾り糸ループ* - (上) / Top Smocking Looper
 飾り糸ループ* - (下) / Bottom Smocking Looper

カム No. CAM No.							
No. 7 品番 PART No. 04-357							
No. 8 品番 PART No. 04-358							
No. 9 品番 PART No. 04-359							

カム No. CAM No.							
No. 10 品番 PART No. 04-360							
No. 12 品番 PART No. 04-362							
No. 13 品番 PART No. 04-363							

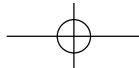

JJ SERIES

KANSAI SPECIALオリジナルのオーバーロックマシン“UK”シリーズがリニューアルしました。

JJ3000シリーズは1本針から3本針までのオーバーロック、インターロックマシンです。

特徴 ① クローズドタイプの針棒機構 ② 針糸、針冷却装置を標準装備 ③ 低振動、低騒音 などに加えてサブモデル、オプションも豊富で拡張性も高く、経済性を重視したモデルです。また、モーターをマシン本体に直接接続したダイレクトモーター仕様も新たに加わり、さらなる省電力・低振動を実現しています。

KANSAI SPECIAL “JJ3000 Series” is launched now with numerous modifications. “JJ series” is 1 to 3 needles overlock and interlock machine. It contains a number of new features and benefits.

Major features are as follows: ① Closed type (fully sealed) needle bar drive mechanism. ② Built-in needle & thread cooler ③ Low vibration, low noise in this new series we can offer also the direct drive, that can save more energy and realize less-vibration, low noise.

Fresh feeling, user-friendly design, operating the brand new KANSAI SPECIAL’s JJ machine makes your work neat and clean.

KANSAI SPECIAL “La serie JJ3000” es lanzado con tantas modificaciones.

Esta nueva serie JJ viene de 1 a 3 agujas con puntada de seguridad.

Las características mayores tales como : ① El mecanismo de la barra de agujas, esta completamente cerrado ② Sistema de enfriador de agujas/agujas interior ③ Minima vibracion, minimo ruido Se puede equipar el motor directo en esta nueva serie que ahorra energia electrica y realiza minima vibracion, minimo ruido.

La nueva serie JJ de Kansai Special hace que su trabajo sea nitido y limpio.

JJ3000 系列有 1 针至 3 针的包缝和安全缝包缝机。

特性 ① 密闭式的针杆结构 ② 针线和机针的冷却装置为标准装备 ③ 低振动，低噪音 还可以加配多款装置和自选装置 JJ 系列非常重视机器扩充性和经济性

JJシリーズ モデル表示方法

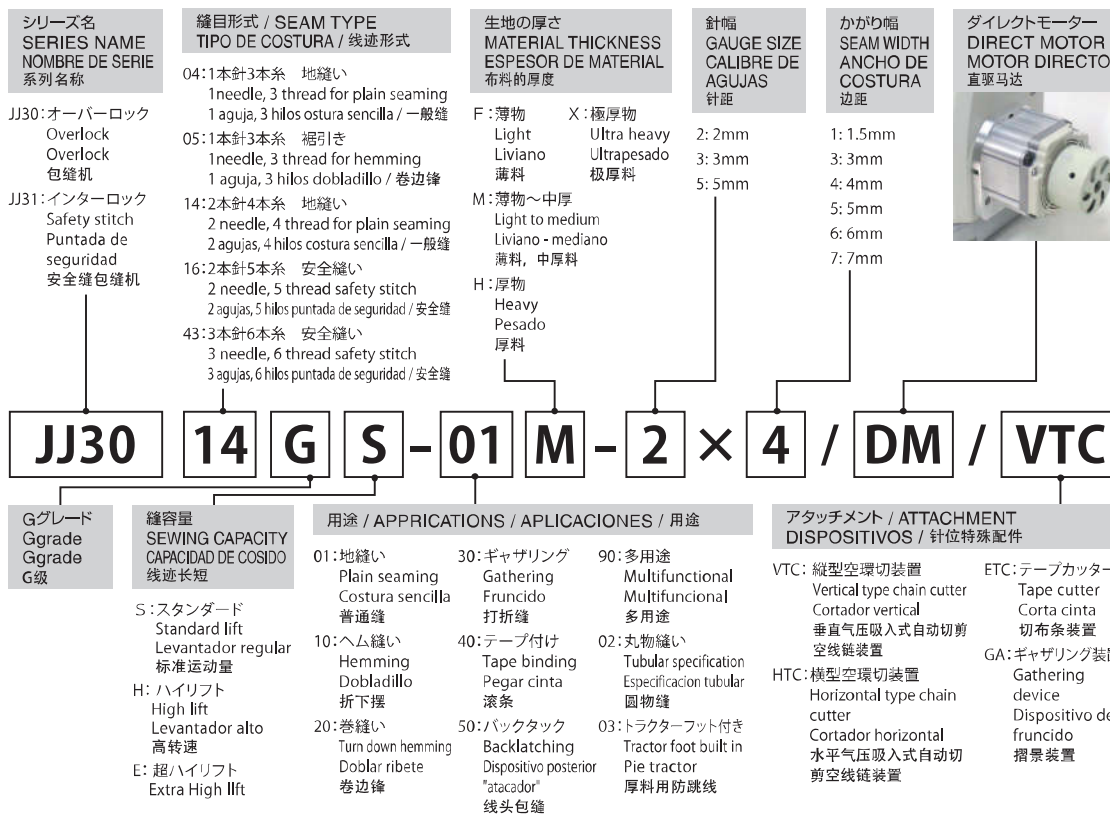

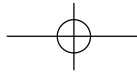

INDUSTRIAL SEWING MACHINES
PRODUCTS GUIDE

OVER LOCK

JJ•UK-WG SERIES

JJ3014GH-01M
JJ3014GH-40M
JJ3014GE-01H



2本針オーバーロックミシン地縫い用(01M)、
テープ付け用(40M)
主に薄物から中厚までのTシャツ、40Mはニット製品の
肩帯テープ付けに最適です。

2 needle, overlock machine 01M for plain sewing
and 40M for attaching tape
Suitable for sewing materials such as T-shirts,
knit wear, and etc.

2 agujas, maquina de overlock para pegar
cinta. Conveniente para materiales delgados
tales como camiseta, prendas de punto, etc

2 针 4 线肩带包缝机 (01M, 40M), 最适宜从薄料到
中厚料的 T 恤等针织产品的缝肩带用 (2014H-40M)

JJ3014GH-01M

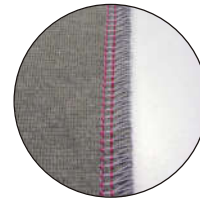

JJ3014GH-40M

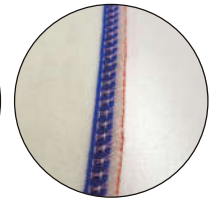



JJ3014GH-01M



JJ3014GH-40M



	JJ3014GH-01M-2x4 JJ3014GH-40M-2x4	JJ3014GE-01H-2x4
 fabric thickness	薄物~中厚 light to medium High lift	中厚~厚物 medium to heavy Ultra High lift
 Overedge width	4mm	4mm

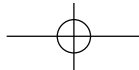

OVER LOCK

JJ3116GS-01M



- 2本針安全縫いミシン
- 2 needle, safety stitch machine
- 2 agujas, maquina de puntada de seguridad
- 2 针 5 线安全缝包缝机



JJ3116GS-01H



- 2本針安全縫いミシン厚物用
- 2 needle, safety stitch machine for heavy materials
- 2 agujas, maquina de puntada de seguridad para materiales pesados
- 2 针 5 线安全缝包缝机, 适用于厚料

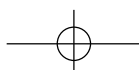

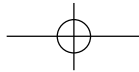

INDUSTRIAL SEWING MACHINES
PRODUCTS GUIDE

OVER LOCK

JJ•UK-WG SERIES

JJ3004GS-20F



1本針縁かがり用オーバーロックマシン

1 needle overlock machine for turn-down hemming

1 aguja, maquina de overlock para doblar ribete

1 针卷缝包缝机



JJ3143GH-90M



3本針多用途安全縫いマシン

3 needle multi-purpose safety stitch machine

3 agujas, maquina de puntada de seguridad para multi uso

3 针安全缝包缝机

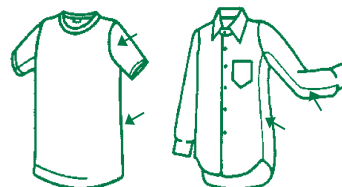

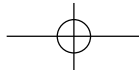

JJ3116GE-03XK

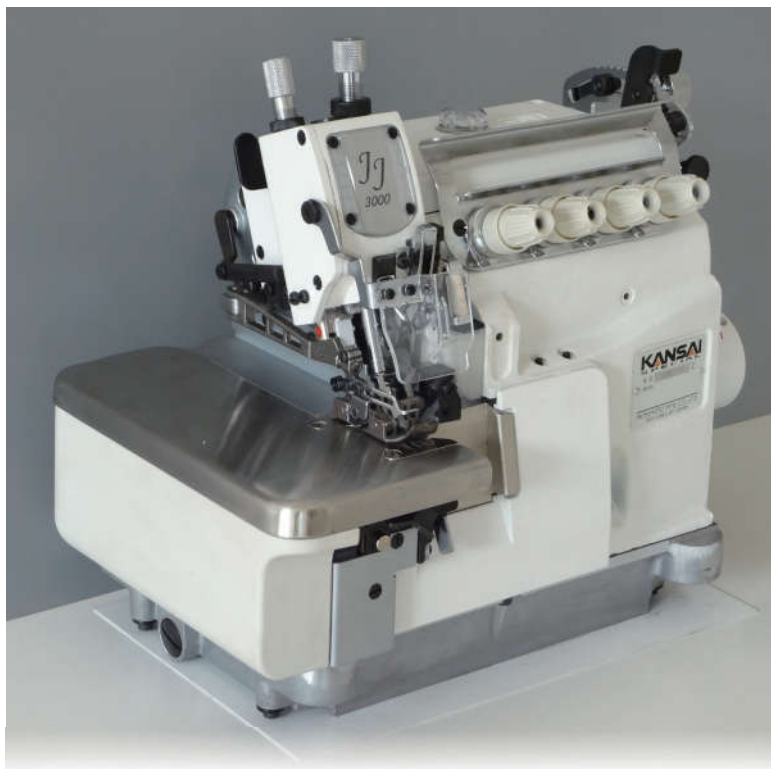

2本針上下差動送り角メス付インターロックミシン

2 needle, safety stitch machine with upper feed mechanism and an angled knife for extra heavy materials

2 agujas, puntada de seguridad con una cuchilla superior en ángulo para materiales extra pesados

5 线上下差动同步安全缝包缝机, 带极厚料用切刀

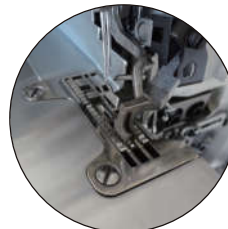

UK2000GH-WG

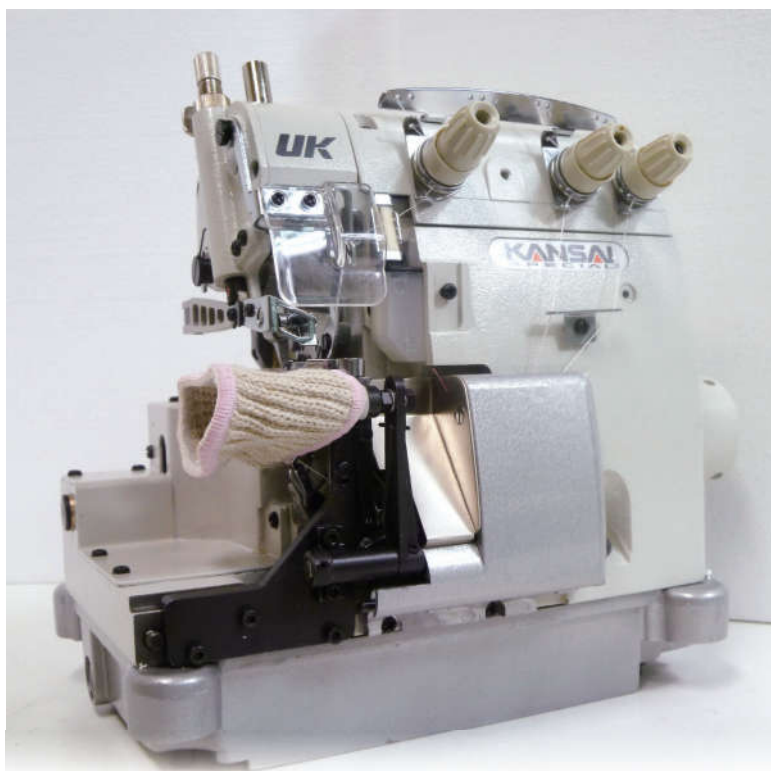

1本針オーバーロックミシン軍用手(手首部分)

1 needle overlock machine for work gloves (wrist part)

1 aguja, maquina de overlock para guante de trabajo (parte de muñeca)

1 针手套专用包缝机。(用于手腕部分)

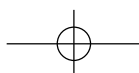
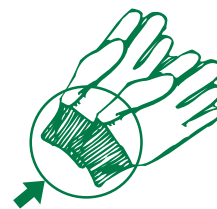

JJ SERIES TECHNICAL DATA 仕様明細

MODEL	Application	Fabric Weight	Type of Needle	No. of Needle	No. of Threads	Needle Space (mm)	Overedge Width (mm)	Stitch Length (mm)	Pitch of Feed dog (mm)	Diff. Feed Ratio	Presser Foot Lift (mm)	Max. Speed (rpm)	Remarks	
			DCx27											
1 本針オーバーロック SINGLE NEEDLE OVERLOCK MACHINE														
JJ3004GS-01M	-4	plain seaming 地縫い	light to medium 薄物～中厚	#9	1	3	/	4	1～3.8	1.6	0.7～2	5	8500	
JJ3005GS-10M	-3	hemming 裾引き	light to medium 薄物～中厚	#9	1	3	/	3	1～3.8	1.6	0.7～2	5.5	8500	
	-4							4						
JJ3004GS-20F	-1	turn down hemming 巻き縫い	light to medium 薄物～中厚	#11	1	3	/	1.5	1～3.2	1.6	0.7～2	5	8500	
JJ3004GS-50M	-3	backlatching バックタック	light to medium 薄物～中厚	#9	1	3	/	3	1～3.8	1.6	0.7～2	5	8500	
	-4							4						
2 本針オーバーロック 2 NEEDLES OVERLOCK MACHINE														
JJ3014GH-01M	-2x3	plain seaming 地縫い	light to medium 薄物～中厚	#9	2	4	2	3	1～3.8	1.6	0.7～2	5.5	8000	
	-2x4							4						
	-2x5							5						
JJ3014GH-40M	-2x4	tape binding テープ付け	light to medium 薄物～中厚	#9	2	4	2	4	1～3.2	1.6	0.7～2	5.5	8000	
	-2x5							5						
JJ3014GE-01H	-2x4	plain seaming 地縫い	medium to heavy 中厚～厚物	#11	2	4	2	4	1～3.8	1.6	0.7～2	5.5	7000	
JJ3014GH-50M	-2x4	backlatching バックタック	light to medium 薄物～中厚	#9	2	4	2	4	1～3.8	1.6	0.7～2	5.5	7500	
	-2x5							5						
2 本針安全縫ミシン 2 NEEDLES SAFETY STITCH MACHINE														
JJ3116GS-01M	-3x4	plain seaming 地縫い	light to medium 薄物～中厚	#11	2	5	3	4	1～3.8	1.6	0.7～2	6	7500	
JJ3116GS-02M	-3x4	plain seaming 地縫い	light to medium 薄物～中厚	#11	2	5	3	4	1～3.8	1.6	0.7～2	6	7500	foot for tubular structure 小廻り用押え付き
JJ3116GS-01H	-3x5	plain seaming 地縫い	heavy 厚物	#14	2	5	3	5	1～3.8	1.6	0.7～2	6	7500	
	-5x5							5						
JJ3116GH-01H	-5x5	plain seaming 地縫い	heavy 厚物	#14	2	5	5	5	1～3.8	1.6	0.7～2	5.5	7000	
JJ311GE-03X	-5x5	plain seaming 地縫い	ultra heavy 極厚物	#21	2	5	5	5	1～5	2.5	0.8～1.5	7	7000	tractor foot トラクターフット
	-5x6							6						
	-5x7							7						
JJ3116GS-30M	-3x4	gathering ギャザー	light to medium 薄物～中厚	#14	2	5	3	4	1～3.2	1.6	0.8～2.8	5	7000	
	-5x5							5						
	-3x4P							3						
JJ3116GE-03XK	-5x6	plain seaming 地縫い	extra heavy 極厚物	#21	2	5	5	5	1～5	2.5	0.8～1.5	7	7	upper feed 上下差動送り付
3 本針安全縫ミシン 3 NEEDLES SAFETY STITCH MACHINE														
JJ3143GH-90M	-3x2x4	plain seaming 地縫い	light to medium 薄物～中厚	#11	3	6	3x2	4	1～3.8	1.6	0.7～2	5.5	7000	

UK2000GH-WG TECHNICAL DATA 仕様明細

UK2000GH-WG	/	Work Glove 作業手袋用	/	#18	1	3～4	/	4	3	/	/	8	5000	
-------------	---	---------------------	---	-----	---	-----	---	---	---	---	---	---	------	--

角メス付き / With an angled upper knife for extra heavy materials / Con una cuchilla superior en ángulo para materiales pesados adicionales / 帯極厚料用切刀

"DOUBLE CHAIN" シリーズ用 オプション |

OPTIONS FOR DOUBLE CHAIN SERIES / OPCION PARA DOUBLE CHAIN SERIES / 双重环系列用的附属品

■ B, NW (B-2000, NW2202)



■ BK20 ベルトループカッター
Automatic cutting device for belt loops.
Cortador para pasadores.
切带装置

■ DLR

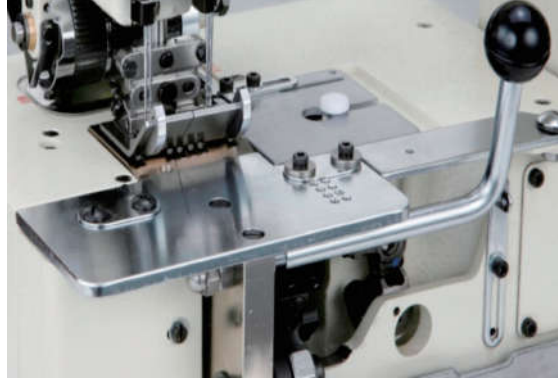

■ TB ターンダウンホルダーブラケット (*1508SPF,1509SPFは標準装備)
TURN DOWN FOLDER BRACKET (*This is standard equipment for 1508SPF,1509SPF.)
EQUIPAMENTO ESTANDAR (PARA 1508SPF, 1509SPF)
拉开式面板 (1508SPF,1509SPF 标准装备)

■ SX



■ CS-3 空環切り装置 (写真はNFS用で類似品)
ELECTRIC CHAIN CUTTER
CORTADOR DE CADENETA
切空线头装置

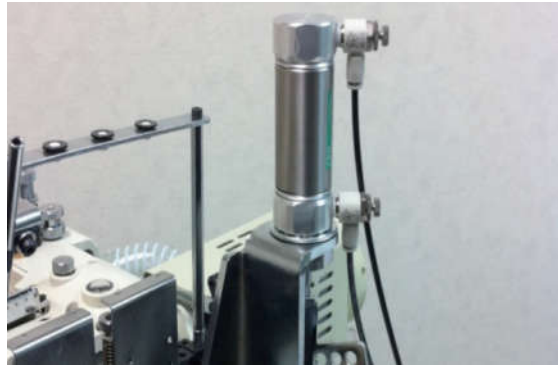

■ FL エアー式押え上装置
AIR TYPE FOOT LIFTER
LEVANTA PIE NEUMATICO
气压式抬压脚装置

"Multi-needle" シリーズ用 オプション |

OPTIONS FOR MULTI-NEEDLE SERIES / OPCION PARA MULTI-NEEDLE SERIES / 多针机的附属品



■ RT-1 ゴム張り装置 (手動式)
DX, FX(PSF, PMD, PLは除く), RX (RX-P, PLKのみ)
RT-1 Elastic expander device (manual operation)
DX, FX (except for PSF, PMD, PL), RX (Only for RX-P, PLK)
RT-1 EXPANDIDOR DE ELASTICO DX, FX, RX
松紧带撑开装置 (DX,FX, 除PSF, PMD, PL, RX-P, PLK)

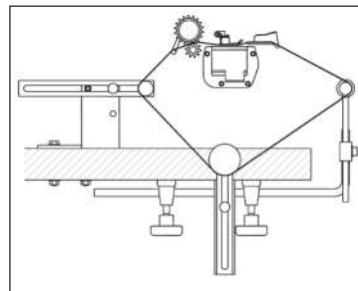

|"TOP & BOTTOM" シリーズ用 オプション |

OPTIONS FOR TOP & BOTTOM SERIES / OPCION PARA TOP&BOTTOM SERIES / 綑缝系列特殊配件



■ CS1 空環切り装置 (VD 集塵装置は別売り)
AIR TYPE CHAIN CUTTER (Except for VD-Venturi device)
CORTADOR DE CADENETA
切空线头装置



■ VD 集塵装置
VENTURI DEVICE
APARATO ASPIRADOR
吸尘装置



■ EW 電気式上糸払い
(電気式ワイパー-NW, NR, NC用)
ELECTRIC TYPE WIPER FOR NW, NR, NC
DESILIZADOR ELECTRICO PARA NW, NR, NC
电动式上勾线



■ AW エアー式上糸払い
(エアー式ワイパー-NW, NR, NC用)
AIR TYPE WIPER FOR NW, NR, NC
DESILIZADOR NEUMATICO PARA NW, NR, NC
气动式上勾线



■ CS-2 空環切り装置 (NFS用)
ELECTRIC CHAIN CUTTER (For NFS)
CORTADOR DE CADENETA PARA NFS
切空线头装置

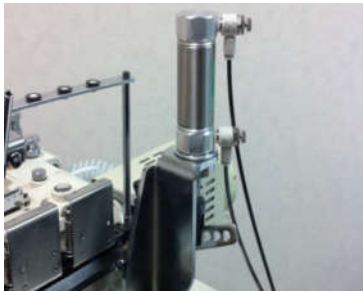

■ FL エアー式押え上装置
AIR TYPE FOOT LIFTER
FL: LEVANTA PIE NEUMATICO
气压式抬压脚装置

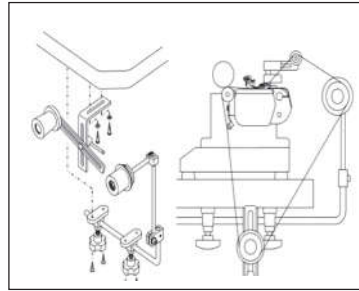

■ RT-2 ゴム張り装置 (手動式) NR-PHK
Elastic expander
(Manual operation) NR-PHK
EXPANDIDOR DE ELASTICO NR-PHK
松紧带撑开装置



■ MC31E 電気式テープカッター (NW-F)
ELECTRIC TAPE CUTTER (For NW-F)
APARATO DE CORTACINTA, TIPO ELECTRICO (PARA NW-F)
电动式切布装置



■ NFS 太径パイプ / BIGGER DIAMETER PIPE
標準装備 / STANDARD DEVICE
EQUIPAMENTO ESTANDAR / 标准配件

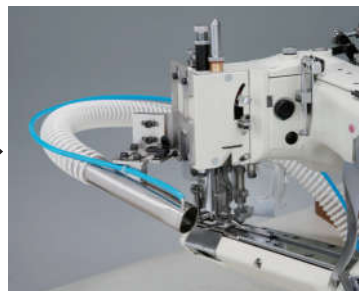

オプション / OPTION
OPCIÓN / 选项

■ モデル別テープカッター
TAPE CUTTER DEVICES

	TYPE OF TAPE CUTTER	
	ELECTRIC	PNEUMATIC
For NW8803GF	MC31FE	MC31FA
For WX88 × × EMK	MC30EMKE	MC30EMKA
For WX88 × × -1S	MC30SE	MC30SA

|"Overlock" シリーズ用 オプション |

OPTIONS FOR OVERLOCK SERIES / OPCION PARA OVERLOCK SERIES / 包縫系列的附属零件



■ VD 集塵装置
VENTURI DEVICE
APARATO ASPIRADOR
吸尘装置



■ JJシリーズオプション組み合わせ
COMBINATION OF OPTIONAL DEVICES

Vacuum device	HTC (Horizontal Chain Cutter)	FL Foot Lifter	Compatible motor
	VTC (Vertical Chain Cutter)		
SD10	×	○	Clutch
SD20	○	×	
SD30	○	○	
SD40	×	○	Servo
SD50	○	×	
SD60	○	○	

*HTC, VTC, FLは別オプション
*HTC, VTC and FL are optional



■ VTC 縦型空環切り装置
VERTICAL CHAIN CUTTER
(chain off is cut and is sucked by air at side behind the needle plate)
CORTADOR DE CADENETA, TIPO VERTICAL
纵向切线装置



■ HTC 横型空環切り装置
HORIZONTAL CHAIN CUTTER
(chain off is cut and is sucked by air horizontally behind the needle plate)
CORTADOR DE CADENETA, TIPO HORIZONTAL
横向切线装置



■ FL エアー式押え上装置
AIR TYPE FOOT LIFTER
LEVANTA PIE NEUMATICO
气压式抬压脚装置

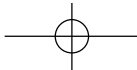

仕様・外観等は予告なく変更されることがあります。

Specifications and appearances are subject to change without prior notice.

Las especificaciones y la apariencia y pueden estar sujetas a cambios sin previo aviso.

规格和外观的修改恕不事先通知

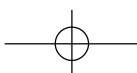

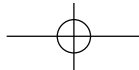

 **MORIMOTO MFG. CO., LTD.**

1-4-17, SUNA SHIJOHNAWATE-CITY, OSAKA 575-0001, JAPAN

TEL : +81-72-877-1221 FAX : +81-72-878-9649 E-MAIL : hqeigyo@kansai-special.com URL : www.kansai-special.com

FOREIGN AFFILIATED COMPANIES

KANSAI SPECIAL AMERICAN MACHINE CORP.

1 MADISON ST. BLDG.F, EAST RUTHERFORD, N.J. 07073 U.S.A.

TEL : +1-973-470-8321 FAX : +1-973-470-8497 E-MAIL : sales@kansaispecial.net

KANSAI SPECIAL EUROPE GMBH

QUIRINSTR.19, 40545 DUSSELDORF, GERMANY

TEL : +49-211-577-9090 FAX : +49-211-558-1477 E-MAIL : Contact@kansai-special.de

MORIMOTO SINGAPORE PTE LTD.

51 PENJURU ROAD, #02-02 SINGAPORE 609143

TEL : +65-6334-1305 FAX : +65-6334-1365 E-MAIL : info@kansaispecial.com.sg

MORIMOTO SINGAPORE PTE LTD INDIA LIAISON OFFICE

No.11, SENTHILL NAGAR, PERRIYAR COLONY, AVINASHI ROAD, TIRUPUR, INDIA 641652

TEL : +91-421-4248229 FAX : +91-421-4248228 E-MAIL : india@kansaispecial.com.sg

MORIMOTO SINGAPORE PTE LTD BANGLADESH LIAISON OFFICE

HOUSE #16, FLAT #2-B, ROAD #13, SECTOR #4, UTTARA, DHAKA-1230, BANGLADESH

TEL : +880-2-8931702 FAX : +880-2-8931704 E-MAIL : salesbangladesh@kansaispecial.com.sg

KANSAI (SHANGHAI) INDUSTRIAL SEWING MACHINE CO., LTD.

NO.55 LANE835, JIAXIN ROAD, MALU TOWN, JIADING DISTRICT, SHANGHAI 201818

TEL : +86-21-5990-1798 FAX : +86-21-5990-1538 E-MAIL : kansaish@spe.sina.net

PARTS CENTER - KANSAI SPECIAL (HONG KONG)

UNIT B&D, 6/F, WING HONG CENTRE, 13 WING HONG ST., LAI CHI KOK, KOWLOON, HONG KONG

TEL : +852-2391 8357 FAX : +852-2789 1707 E-MAIL : parts@kansaispecial.com.hk

关西(上海)工业缝纫机有限公司

上海市嘉定区马陆镇嘉新公路 835 弄 55 号 邮编 : 201808

TEL : 021-5990 1798 FAX : 021-5990 1538 E-MAIL : kansaish@spe.sina.net

2016.03

